



የኢትዮጵያ ጠቅላይ ሚኒስትር የጥቅም ስራ ሚኒስቴር
የኢትዮጵያ ጠቅላይ ሚኒስትር
The Federal Democratic Republic of Ethiopia
Ministry of Communication & Information Technology



የኢትዮጵያ ጠቅላይ ሚኒስትር የአካባቢ ጥበቃ ሚኒስቴር
የኢትዮጵያ ጠቅላይ ሚኒስትር
The Federal Democratic Republic of Ethiopia
Ministry of Environment and Forestry

FINANCING MODELS FOR SOUND E-WASTE MANAGEMENT IN ETHIOPIA

Final Report, London, 29 May 2015



Report commissioned by UNIDO in the project
“E-Waste Management in Ethiopia funded by the GEF



TABLE OF CONTENTS

Table of contents	2
Abbreviations	3
Executive summary	4
1 Background	7
1.1 Objectives of the Study	7
1.2 The context of e-waste management	7
1.3 The societal need of e-waste management systems	8
1.4 The financing of e-waste management: challenges and opportunities	9
1.5 The Extended Producer Responsibility (EPR) principle	17
1.6 The EPR in the e-waste context	18
2 Examples of financing models: EPR and beyond	21
2.1 European Union and national transpositions	21
2.2 California	30
2.3 Japan	36
2.4 Ghana	39
2.5 South Africa	45
2.6 Kenya	48
3 Policy options for financing e-waste management in Ethiopia	52
3.1 Boundary conditions for the Financing of e-waste management in Ethiopia	52
3.2 Financing models for e-waste management	60
4 Recommendations for financing e-waste management in Ethiopia	80
5 References	83
6 Annex 1 – Economic modeling of e-waste management costs	84
6.1 Access to waste	84
6.2 Cost for collection	87
6.3 Transportation	89
6.4 Treatment	90

ABBREVIATIONS

C&F	Cooling and freezing appliances (incl. Fridges, Freezers and Air Conditioners)
CRT	Cathode Ray Tube
EEE	Electrical and Electronic Equipment
EPR	Extended Producer Responsibility
PPP	Polluter Pays Principle
LAMPS	Lamps
LCD	Liquid Crystal Display
LHHA	Large Household Appliances (incl. Washing machines, Dishwashing machine,...)
MSW	Municipal Solid Waste
PWB	Printed Wiring Boards
SHA	Small Household Appliances (incl. PC, printers, vacuum cleaners, laptop,...)
SMALL IT	Small IT Appliances (incl. mobile phones, GPS, portable audio/video,...)
WEEE	Waste Electrical and Electronic Equipment

Author:
Federico Magalini
Federico.magalini@cyrclé.it

EXECUTIVE SUMMARY

This report was commissioned by UNIDO in project “E-waste Management Project in Ethiopia” (EwaMP Ethiopia), which is financed by the Global Environmental Facility (GEF).

Modern electronic products have revolutionized the world: are used in areas such as education, communication, medicine, transportation, health, food-supply, security, environmental protection and culture.

For their production various materials are used, including certain precious metals and critical resources.

After use those products are discarded– sometimes after re-use cycles in countries different from those where they were initially sold – becoming what is commonly called e-waste.

E-waste is usually regarded as a waste problem, which can cause environmental damage and human health severe consequences if not safely managed. On the other hand e-waste is more often seen as a potential source of income for individuals and entrepreneurs aiming at recovering the valuable materials contained in electronic products.

Securing reliable and undistorted access to such raw materials has become a critical challenge to ensure the production and supply of those products and functionalities to a growing number of people on the planet. On the other hand e-waste contains significant amounts of toxic and environmentally sensitive materials and is thus extremely hazardous to humans and the environment, if not properly disposed of or recycled.

For those reasons a growing number of counties, since 1990 started to develop and enforce e-waste management legislations; e-waste management poses environmental, economic, and social, challenges:

- E-waste contains materials that are considered toxic; safe disposal and handling might be complicated and have relevant costs.
- E-waste contains valuable and scarce materials; this is why business opportunities and “green jobs” can be created and enabled.

In many cases the costs of proper collection and recycling e-waste might exceed the revenues generated from the recovered materials: this is why a proper financing mechanism, tailored on the societal context of the country need to be defined first and enforced afterwards.

From a broader perspective, there are three main stakeholders who could bear financial responsibility for end-of-life management of any kind of waste (i) entire society, (ii) waste holders or (iii) producers.

The report analyses different examples of e-waste legislations and related financing mechanisms in different regions, highlighting their pros/cons, particularly on financing. The examples described include:

- EU WEEE Directive, a massive example of EPR implementation.
- California, where consumers are paying for e-waste management upon purchase of new appliance.
- Japan, where consumers are paying for e-waste management when disposing the equipment.
- Ghana, where the current e-waste bill is proposing a model where financial responsibility is allocated to Producers but the organizational role remains with the government.
- South Africa, where a new plan based on EPR, foresees that producers are paying to a central body that is subsequently transferring the money to a producer responsibility organization (PRO).
- Kenya, where the current e-waste bill is proposing a model, based on EPR, where producers pay net treatment costs directly to recyclers.

The different models has been analysed taking into account the Ethiopian context and four different policy options are presented for Ethiopia: (i) based on electricity bill (or municipal solid waste fee) increase, (ii) on increase of products sale price, (iii) on pure EPR and (iv) a shared responsibility model which combines the EPR with the electricity bill mechanism.

E-waste management costs in Ethiopian context are estimated and detailed.

Not all the models discussed are in line with EPR principle, which is currently proposed in the draft Ethiopian legislation, but all show elements of strength and some weaknesses.

The shared responsibilities approach appears to match better local conditions of Ethiopia, and has the potential to be successfully implemented in the country for the following reasons:

- Is based on EPR and thus in line with the proposed legislation.
- Could ensure a fair allocation of financial responsibilities among two different stakeholders; Producers are responsible for collection, transportation and treatment, in line with the most common approaches established worldwide and nowadays supported by Industry.
Society, through electricity bill (or MSW fee) slight increase equal to less than 1,5 % is made responsible for the financing of access to waste.

Access to waste cost is indeed one of the roots of financial in-efficiencies of the e-waste recycling chain in most of developing countries. Allocation of access to waste financing to society might contribute in minimizing the financial contribution of private sector and thus increasing the likelihood of good willingness to implement the system across the entire country.

In any case, irrespective the model selected, the following recommendations should be considered:

- Establish the principle of “non taxable revenue” for access to waste contributions paid to individuals of entities delivering the waste to the formal collection points could create a positive incentive to channel material to the formal channel.

- Fair competition between logistics providers and recyclers should be established. It's one of the key drivers for long-term cost-effectiveness of the entire system as long as minimum quality standards are defined and enforced.
- Transparency on the real recycling costs should be pursued also to increase the awareness of the consumers and the society at large on the financial requirements of a proper e-waste management.
- Any EPR-based system has in a proper definition of the Producer the cornerstone: this cannot only refer to the manufacturer or the brand of the individual product. Should refer all the entities locally producing or assembling electronic products, or importing new or used equipment that are sold on national market.
- Efforts to tackle and contrast smuggling, particularly in EPR-based system should be strengthened as escaping from e-waste financing responsibilities might create further market asymmetries between the legitimate industry and other players.

1 BACKGROUND

UNIDO and the Federal Democratic Republic of Ethiopia with financial support from the Global Environmental Facility (GEF) have launched the E-waste Management Project in Ethiopia (EWaMP) to promote and upscale the management of E-waste in Ethiopia. The project was initiated and prepared by StEP with financial and organizational support from the US Environmental Protection Agency. EWaMP will assist the Ethiopian Government to establish a national E-waste strategy including: e-waste regulations, collection and treatment, a sustainable financing mechanism, capacity building and awareness raising, and a regional cooperation to create synergies and share best practices.

1.1 OBJECTIVES OF THE STUDY

UNIDO commissioned this study within the Ethiopian E-waste Management Project (EwaMP Ethiopia). The main objective was to enable the Ethiopian Government to make informed decisions about a financing model for e-waste management in Ethiopia by performing the following tasks:

- Give overview on the components of e-waste management that need to be financed.
- Give an overview on financing models for e-waste management applied in different countries and regions of the world.
- Elaborate financing models for Ethiopia and work out the pros and cons of each model in the Ethiopian context.
- Recommend financing models for e-waste management in Ethiopia.

1.2 THE CONTEXT OF E-WASTE MANAGEMENT

Over the last decades the electronics industry has revolutionized the world: electrical and electronic products have become ubiquitous of today's life around the planet. Without these products, modern life would not be possible in developed and developing countries. These products are used in areas such as medicine, transportation, education, health, food-supply, communication, security, environmental protection and culture. In many cases, functionalities enabled are strongly connected with sustainable development and with some of the Millennium Development Goals.

After use those products are discarded– sometimes after re-use cycles in countries different from those where they were initially sold – becoming what is commonly called e-waste.

E-waste is usually regarded as a waste problem, which can cause environmental damage and human health severe consequences if not safely managed. On the other hand e-waste is more often seen as a potential source of income for individuals and entrepreneurs aiming at recovering the valuable materials (metals in particular) contained in discarded equipment. Treatment processes of e-waste aim thus to either remove the hazardous components and

recover as much of the main materials (e.g. metals, glass and plastics) as possible; achieving both objectives is most desired.

It has been over a decade since national and international regulatory authorities began to develop policies (initiated in 1990 in Switzerland) to address the challenge of sound e-waste processing. Compared to traditional waste streams, **e-waste handling poses anyway unique and complex challenges**, including:

- The **heterogeneity of appliances**, in terms of size, weight, function and material composition (most of these properties change over time), and subsequently, in environmental impact at end-of-life;
- The continuous introduction of new products and features, such as the shift from heavy Cathode Ray Tube (CRT) to Liquid Crystal Display (LCD) televisions, introduction of tablets, along with a progressive reduction in average lifespans of products **calling for continuous development of appropriate treatment** technologies;
- The presence or phasing out of certain constituent elements or potentially **hazardous substances** in appliances, such as ozone-depleting substances, mercury and other heavy metals, that **require proper treatment**;
- The relatively **high use of certain precious metals and critical resources** (e.g., gold, silver, ruthenium, indium, platinum group metals, rare earth elements) and the challenges in their recovery due to the “dissipated” nature of the low-concentration elements and the **technological complexity** involved in **recovering** them in recycling processes;
- The **large and diverse group of actors involved in various end-of-life activities**, such as collection, recycling and treatment, reuse, refurbishment, waste disposal and export of products and fractions.

Electronic products are useful and their penetration rate is constantly growing. Sooner or later they are becoming waste and need to be handled properly to protect human health and environment and recover critical resources.

1.3 THE SOCIETAL NEED OF E-WASTE MANAGEMENT SYSTEMS

One common element crosscutting modern technological improvements is the massive use of key metals. Most people are usually not aware that feldspar is used in the production of television and computer screens or car headlamps; copper and aluminium are used in cables that transport electrical power over great distances to the most remote locations, zinc protects the steel infrastructure that supports cables, mercury in compact fluorescent lamps and rare earth in Light-Emitting Diode (LED).

Some high tech metals are indispensable for flat-screen televisions, mobile phones and countless other products. Antimony, cobalt, lithium, tantalum, tungsten and molybdenum are widely used on a range of electronic products. The same group of high-tech metals are also fundamental to new environmentally friendly products like solar panels requiring indium, gallium, selenium and tellurium.

In many cases the electronics industry annually uses relevant shares of primary production of those metals (if we only count electrical and electronic equipment (EEE) this can range from 4% of Platinum to 44% of Copper, up to 72% in the case of Ruthenium).

Securing reliable and undistorted access to such raw materials has become a **critical challenge to ensure the production and supply** of those products and functionalities **to a growing number of people** on the planet.

On the other hand **e-waste contains significant amounts of toxic and environmentally sensitive materials** and is thus extremely hazardous to humans and the environment, if not properly disposed of or recycled. The materials, which are of principal concern with regard to environmental, and health risks include brominated flame-retardants, cadmium, mercury or lead, to name just a few. Landfills, though widely used for waste disposal, are subject to leaking and e-waste disposed of in landfills can leach heavy metals and other toxic substances like mercury, cadmium and lead into the soil, groundwater and atmosphere. Plastics pose a significant environmental risk for reasons other than toxicity, most notably due to the durability and longevity of material.

Recently **for a growing number of people recycling and separation of e-waste became a main source of income**. In most cases, though, this is done informally, with no or hardly any health and safety standards, exposing workers and the surrounding neighbourhoods to extensive health dangers as well as leading to a substantial environmental pollution.

Moreover, recycling here usually focuses on a few valuable elements like gold and copper (with often poor recycling yields), while most other metals are discarded and inevitably lost.

Proper e-waste management is needed to secure future access to key elements needed to supply to growing number of persons products and functionalities.

Proper e-waste management is needed to preserve environment and human health of workers and society at large and ensure effectiveness in recycling operations.

1.4 THE FINANCING OF E-WASTE MANAGEMENT: CHALLENGES AND OPPORTUNITIES

As pointed out in previous sections e-waste poses diverse challenges, involving environmental, economic, social, and health aspects, whereby all stakeholders need to participate in the development and the implementation of solutions:

- **E-waste contains materials that are considered toxic**, such as lead, mercury, cadmium, arsenic, PBDEs, PCBs, PCDD/Fs and PFAS which are harmful to the

environment and human health. Safe disposal and handling might be very complicated, particularly in the context of developing countries and might have relevant costs.

- **E-waste contains valuable and scarce materials** and recovery of these materials as secondary resources can alleviate mining of virgin materials - and is oftentimes much more efficient compared to mining. This is why **business opportunities** and “green jobs” can be created and enabled.
- In some cases the **costs of proper collection and recycling e-waste might exceed the revenues generated from the recovered materials**. This is primarily due to the complexity of product design and difficulty of separating highly commingled materials.

This is why a proper financing mechanism, tailored on the societal context of the country need to be defined first and enforced afterwards: players (individuals or organizations) involved along the e-waste recycling chain carry out activities.

Those activities are in some cases remunerated by the revenues generated, but in some cases they are not and a proper financing is required to remunerate the activities needed for proper e-waste management.

A proper financing scheme should be defined to make sure the e-waste generated in the country is properly treated and the societal benefits are maximised.

Revenues generated by proper recovery of material might not suffice.

1.4.1 ACTIVITIES AND COSTS ALONG THE E-WASTE RECYCLING CHAIN

Before defining a financing model it is important to acknowledge the different activities that are needed in the context of proper e-waste management. Activities and costs associated can be divided into two main clusters: technical costs and framework costs ([Figure 1](#)).

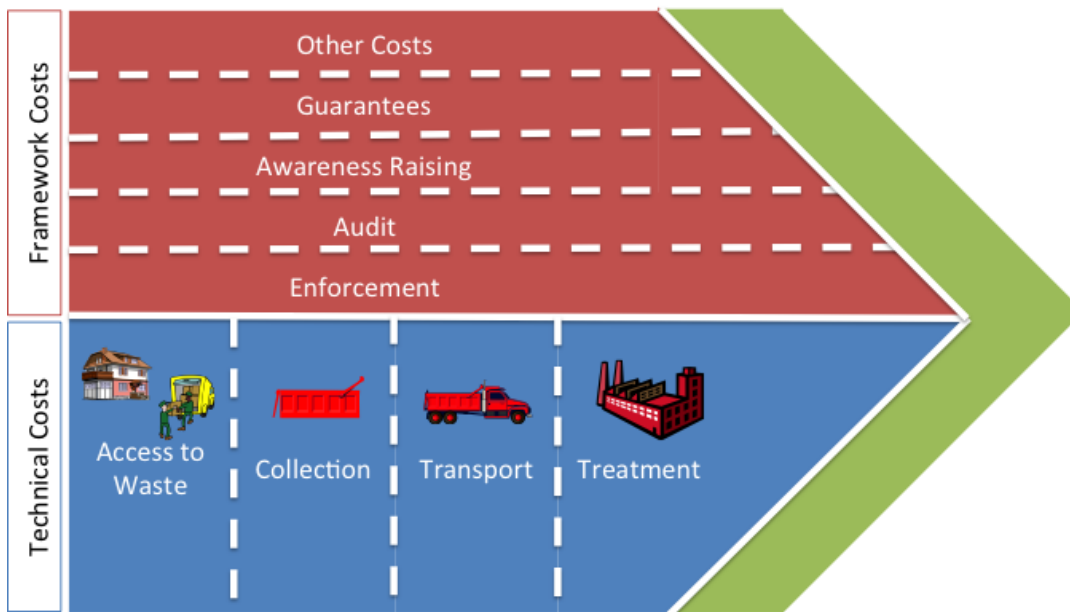

Figure 1: Activities and costs along the e-waste recycling chain.

Technical Costs

Technical costs are those **associated with take back** (collection, transport, treatment and disposal) **operations**. Technical costs represent the **net remuneration for all the activities** carried out by different players along the e-waste recycling chain to ensure e-waste disposed by the holder is collected and properly treated. Technical costs can be divided in 4 groups:

- **Access to waste:** includes the costs (or revenues) to get the waste from the original holder (the consumer). In the majority of developed countries consumers get rid of their waste for free (or in some cases they have to pay for that); In the context of developing countries in most of the cases it is the opposite: the holder of the product to be discarded expects an economic compensation when disposing off the waste. Access to waste is considered a cost when the waste holder is receiving economic compensation. It will be considered revenue when the consumer will pay for disposing it.
- **Collection:** includes the cost for hiring, purchasing (or the corresponding depreciation) the collection infrastructures like containers, cages, bins used to collect and store waste at the collection points. This also includes salary of staff at collection points.
- **Transport:** includes all the transportation costs from the collection point or from the consumers' house/place to the treatment plant.
- **Treatment:** represents the net costs for proper treatment, including disposal of hazardous fractions. Each treatment plant processing e-waste incurs in operative costs: labour costs, energy costs, depreciation of capital investment, other costs related to the

functioning of the plant itself; e-waste being processed into the plant is dismantled and results in different fractions that are sold on national or international commodities markets.

Some fractions have positive value (representing a revenue) while others have a negative value for disposal or further treatment (representing a cost) as shown in Figure 2.

The evaluation of the net treatment cost is based on a straightforward economic balance of all costs and revenues:

$$\begin{aligned}
 \text{Net treatment costs} &= \text{Fractions positive value} \\
 &- \text{Operative Costs (labour, energy, depreciation, others)} \\
 &- \text{Fractions negative value} - \text{Profit Margin Plant}
 \end{aligned}$$

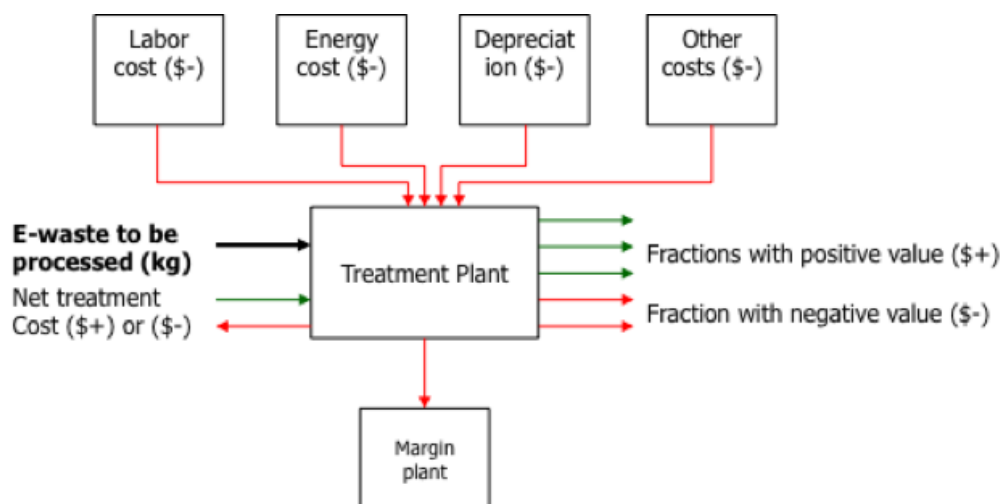

Figure 2: Assessment of net treatment costs.

When the revenues generated on downstream markets are not sufficient to offset the costs for proper disposal of fractions having a negative value, or the operative costs are particularly high, the net treatment cost is negative (Table 1).

This means that without external financial support the e-waste treatment cannot happen, or the treatment plant will otherwise go bankrupt. This is the case for certain products (f.i. lamps, LCD containing mercury backlights or CRT screens, refrigerators) or the case of countries with limited development of downstream markets.

Product with negative treatment cost (theoretical example Refrigerator)			
Material Composition	(Kg/product)	Costs/Revenues (\$/kg)	Cost/Revenue s (\$/unit)
Iron	20	0.15 \$	3.00 \$
Copper	3	4.00 \$	12.00 \$
Aluminium	5	1.50 \$	7.50 \$
Plastics	17	-0.25 \$	-4.25 \$
Other hazardous/non valuable fractions	5	-1.00 \$	-5.00 \$
Total	50		13.25 \$
Labour Cost	Estimated on the basis of salaries of workers, time needed to dismantle properly one refrigerator, ... Usually calculated on the basis of total annual costs, divided by the number of products processed (same as other costs listed below).		-6.00 \$
Energy Cost	Estimated on the basis of the plant consumption for all the activities (incl. machines, illumination,...)		-2.00 \$
Depreciation	Include the share of the capital investment for all the machinery, ..		-2.00 \$
Other costs	Other administrative costs, costs for conformity,...		-4.00 \$
Total Operative costs			-14.00 \$
Expected Margin	Decided or estimated by the management of the plant.		2.00 \$
Net treatment cost	Resulting from Intrinsic value of the product, operative costs and expected margin. Negative net treatment costs means that proper treatment of the product needs to be financially supported by external stakeholders.		- 2.75 \$

Table 1: Calculation of net treatment cost in the case of refrigerators (values are indicative, with the purpose of detailing the calculations).

When the revenues generated on downstream markets are offsetting the costs for proper disposal of fractions having negative values plus the operative costs, the net treatment cost is zero or even positive (Table 2).

This means that the plant can pay for the e-waste entering the plant: there is no need of external financial support for the e-waste treatment. The extra revenues generated by products with a net treatment costs can be used in different ways (depending on the decisions of each plant management): can be used to purchase waste from holders, as the more waste is treated the higher is the total margin of the plant and economies of scales on operative costs can be achieved, or can be used to off-set part of the negative treatment costs of other products, so that the external financial support is minimized.

Waste streams and products with positive net treatment costs are common in many countries when treatment plants are long-time running and the markets are consolidated.

The below table exemplarily shows the net treatment cost for a desktop PC.

Product with positive treatment cost (theoretical example Desktop PC)			
Material Composition	(Kg/product)	Costs /Revenues (\$/kg)	Cost/Revenues (\$/unit)
Iron	2	0.15 \$	0.30 \$
Copper	1,5	4.00 \$	6.00 \$
Aluminium	0,5	1.50 \$	0.75 \$
Plastics	2,5	-0.25 \$	-0.63 \$
Other hazardous/non valuable fractions	0,5	-1.00 \$	-0.50 \$
Total	7		5.93 \$
Labour Cost	Estimated on the basis of salaries of workers, time needed to dismantle properly one refrigerator,...		-1.50 \$
Energy Cost	Estimated on the basis of the plant consumption for all the activities (incl. machines, illumination,...)		-0.50 \$
Depreciation	Include the share of the capital investment for all the machinery, ..		-0.50 \$
Other costs	Other administrative costs, costs for conformity,...		-1.00 \$
Total Operative costs			-3.50 \$
Expected Margin	Decided or estimated by the management of the plant.		1.00 \$
Net treatment cost	Resulting from Intrinsic value of the product, operative costs and expected margin. Positive net treatment costs means that proper treatment of the product does not need to be financially supported by external stakeholders.		1.43 \$

Table 2: Calculation of net treatment cost for a desktop PC (values are indicative, with the purpose of detailing the calculations).

Each treatment plant, depending on individual costs and downstream markets, usually calculates net treatment costs and offers to customers the services in a competitive scenario where other plants exist.

This is in particular important to keep costs down at a minimum as otherwise those stakeholders financing the system might not accept to finance the e-waste management system and avoid payments.

Fair competition on net treatment costs is one of the key elements enabling cost optimization in medium term along the entire recycling chain.

Fair technical costs for proper e-waste management can be financed in some cases by revenues generated on downstream markets.

In other cases external financial support is needed, particularly for certain products or waste streams.

Framework costs

Framework costs are associated to all those activities enabling operations or monitoring the proper functioning of the system, ensuring all relevant provisions are enforced and enacted, creating a level playing field for all stakeholders. Framework costs can be divided in 5 groups:

- **Enforcement:** includes all the costs for enforcement of all provisions; costs for control that producers are registered and each stakeholder fulfil his own role and take care of responsibilities in the system.
- **Audit:** includes the costs for auditing the treatment plants and other relevant stakeholders involved in the e-waste recycling chain to ensure all the provisions are properly enforced, and preventing or sanctioning un-fair or illegal behaviour.
- **Awareness raising:** includes the costs for raising public awareness on the importance of proper e-waste management, indications on how to properly dispose e-waste and public campaigns.
- **Guarantees:** include the costs covering the situations where a producer ceases to exist (goes bankrupt, or is no longer active on the market...) or for other reasons cannot assume the financing of its share of e-waste. The EU WEEE Directive introduced the request of financial guarantees (chapter 2.1) for household appliances placed on the market after the entry into force of the WEEE Directive.

In the majority of cases the participation of Producers in a collective compliance scheme is considered as a guarantee; alternatives are insurance policies or blocked bank accounts.

Despite different theoretical models exist, in practice e-waste is being processed and financed according to the so-called “pay-as-you-go” mechanism. This means that costs arising in a given year (technical and framework ones) are allocated to entities

responsible to bear the costs in the same year. Allocation can be based on market share (most common in EPR models) or according to other principles described in chapter 2.

- **Other Costs:** includes other addition costs not belonging to previous categories.

1.5 THE EXTENDED PRODUCER RESPONSIBILITY (EPR) PRINCIPLE

Thomas Lindqvist (Lindqvist, 1992) originally introduced the **Extended Producer Responsibility** (EPR) concept in early 90'; the concept has been progressively used and adopted in different sectors. Now the OECD (OECD, 2006) defines EPR as “*an environmental policy approach in which a producer’s responsibility for a product is extended to the post-consumer stage of a product’s life cycle*”.

The fundamental idea behind EPR, as policy principle, is to provide an economic incentive to producers in order to take into account environmental considerations when designing and manufacturing their products so that waste management can be ultimately improved. **EPR principle aims to shift part of the waste management responsibilities** (administrative, financial and/or physical) from governments or municipalities (and thus taxpayers) **to the entities that produce and sell the products that are destined to become waste**.

From a broader, theoretical, perspective the EPR principle represents also a fundamental shift in the paradigm of the so-called polluter-pays-principle (PPP): the consumer disposing of the waste is no longer seen as the main responsible triggering waste management needs; instead the economic agent making profit on the production and sale of the product (i.e. the producer) is encouraged to take a broader role.

The logical reasoning and the economic incentive is the idea that producers, through eco-design, could design products that last longer and are more easily recycled after use thus reducing the waste management cost for the producer.

EPR appeared in policies in the early 1990s in a few European countries, especially for packaging waste, and since then it has continuously spread around the European Union (and abroad) becoming the cornerstone of different EU Directives for key waste streams, like packaging, end-of-life vehicles, e-waste, batteries, and many others.

Despite the theoretical rationale behind, the use of the EPR principle has not yet proved the real effectiveness on eco-design changes, particularly in the case of complex waste streams like modern electronics. In the implementation of EPR, it has so far not yet proved to be practical to allocate the actual cost of waste management to individual producers’ products. A producer investing in better design thus will have to bear additional cost for better design, but will not have the benefit from it in waste management.

Financing of waste management activities and allocation of economic responsibilities along the downstream chain has proven to be challenging in countries with existing waste management schemes and in countries discussing potential take-back system architectures. **The way**

stakeholders financially contribute to different activities varies and many models exist besides the EPR principle.

From a broader perspective, there are indeed **three main stakeholders** who **could bear financial responsibility** for end-of-life management of any kind of waste:

- **Entire society.** As waste is a societal problem, having impact not only on consumers but also on the entire population (both in terms of environmental and societal impacts), waste management systems could be financed by the entire society (i.e., by **taxpayers**). This is usually the case of municipal solid waste, especially when governmental (central or local) organizations keep control over operations.
- **Waste holders.** This could be seen as an implementation of the “polluter pays principle”, where the polluter is recognized as the person responsible for discarding the waste. This is usually the case of non-household waste, when companies are held responsible for the proper handling of waste produced, or where citizens are charged directly for the waste management on the basis of the actual waste generated and disposed of.
- **Producers.** This is the implementation of the EPR principle in various degrees. It should be noted that although producers ensure the financing of systems, consumers might eventually pay the end-of-life costs via an increase of the product price. Internalization of costs in the product price can result indeed in (i) a reduction of the producer’s sales margins, or (ii) an increase of sales price, resulting in the financial impact indirectly being borne by the consumer. The choice between a reduction of sales margins or an increase in sales price is not strictly dependent on the financing model of the entire system but rather depends on each producer’s strategy and product portfolio.

Waste management costs can be born by different stakeholders: society, waste holders or producers.

Even in the context of the EPR principle the costs can eventually be indirectly borne by consumers.

In any case cost-effectiveness of waste management is important.

1.6 THE EPR IN THE E-WASTE CONTEXT

E-waste management has historically been addressed in policy bills around the world **in the context of EPR, except few cases** that will be described in chapter 2 of the report. Many regions of the world are nowadays looking at European experience in the context of e-waste management as an example of massive implementation of the EPR principle with the introduction of the EU WEEE Directive in 2004.

It combines a unique legislative framework at EU level with the flexibility that each Member State has in transposing, implementing and enforcing the EU Directive’s e-waste management principles in his peculiar, national context, including different degrees of stakeholder

involvement. For these reasons, across the EU various approaches exist in the practical implementation of the EPR principle to e-waste streams under the umbrella of the WEEE Directive.

Few **fundamental elements need** anyway **to be considered when analysing** the use of the **EPR principle** in the context of e-waste management:

- **Definition of Producer:** in an EPR context this cannot only refer to the manufacturer or the brand of the individual product. When the EPR is used as a principle to shift part of the financial contribution for proper e-waste management to producers, **all the entities locally producing or assembling electronic products, or importing new or used equipment** that are sold on national market **can be held responsible** for the proper management of e-waste arising from such products.
- Theoretical background of EPR versus common practice: original reasoning behind EPR theory was to reward individual eco-design efforts of producers; but common practice and implementation on the ground suggest that such an economic incentive is difficult to materialize, especially when it is hard to have access to own products. The greater environmental benefits are linked to **the effectiveness of collection and treatment of e-waste** rather than on the reward of eco-design through individual handling of waste originated from own products.
- **Financial and organizational responsibilities:** there are two main areas where the responsibility of producers can play a fundamental role and which might characterize any model: financial and organizational responsibility.
 - **Pure financial responsibility: producers are simply financing operations** (collection & treatment) already carried out in national context without any further chance to influence or steer the system. This model is **not used in any e-waste legislation** currently in place and is more common, at least across Europe, for other waste streams (f.i. end-of-life vehicles or oil). The current pending proposal of Ghanaian e-waste bill is requesting producers to bear pure financial responsibility and will be discussed in chapter 2.4.
 - **Financial and organizational responsibility:** producers are requested to **finance operations, but have also organizational responsibility**, which might have different degrees of freedom. In the majority of cases producers choose logistics and treatment partners to fulfil their take back obligations. Contracts might be signed directly between producers and transport and treatment service providers or via Compliance Schemes set up for this purpose by producers, as detailed in chapter 2.1. One of the key building blocks for organizational responsibility is the **opportunity to enable a fair competition between service providers** (logistics providers or treatment plants) that might lead to **long-term cost-effectiveness in the system when properly coordinated**.

- **Activities along the e-waste recycling chain financed:** Chapter 1.2 highlighted different type of costs that are relevant in the context of proper e-waste management. **Not necessarily all the activities might be financed under EPR schemes.** This is particularly the case for the framework costs and capital investments for setting up waste management or specific recycling infrastructures, which are also reflected in treatment costs.

In many developing countries the financing of access to waste plays also a crucial role.

The definition of financing models is critical to understanding the design and operation of e-waste take-back systems and is necessary to:

- Clearly assess which activities are financed under the e-waste legislation, and
- Define which stakeholder finances which activity.

Definition and allocation of financial responsibilities is crucial to ensure **cost-effectiveness** of the system to ensure the **financial support is kept to a minimum**.

Cost effectiveness of the system is a paramount, no matter the financial model chosen and **no matter the specific stakeholder responsible for financing** (as detailed in chapter 1.3). Cost effectiveness helps minimizing:

- Taxation levels when taxpayers are responsible for e-waste management or the financial impact on waste holders (companies or consumers) when they are directly responsible for financing;
- Financial responsibilities allocated to producers under an EPR scheme. This has a positive impacts on the society at large as in the case e-waste costs are directly reflected into product price will not have negative impacts on consumers. Recent research has shown how the implementation of the WEEE Directive across EU leads to a sensible increase of product prices (Favot, 2013). But minimizing financial impacts on producers might also reduce the negative impacts on financial wellness of SMEs.
- Transparency on the management of financials can further contribute in keeping cost-effectiveness, particularly ensuring the financial contributions from obliged parties under the e-waste legislation (producers or others) is financing only e-waste management activities and not used for different purposes if becoming part of the general budget of governmental organizations.

Financing of e-waste management has anyway a societal impact (both with or without EPR).

Cost-effectiveness of the entire system should be paramount in the definition and implementation of the financing model.

Transparency on handling of financials along the entire chain can further contribute to cost-effectiveness.

2 EXAMPLES OF FINANCING MODELS: EPR AND BEYOND

In this chapter selected examples of e-waste legislations and related financing mechanisms are presented. The purpose of the chapter is to highlight different approaches nowadays implemented or proposed in different regions, highlighting their pros/cons, particularly on financing. The pre-requisites and peculiarities of different models will also be explained to better understand the background of the legislation. The examples described include:

- **EU WEEE Directive:** a massive example of EPR implementation in terms of population covered and categories and amounts of e-waste collected and treated.
- **California:** consumers are paying for e-waste management upon purchase of new appliances.
- **Japan:** consumers (waste holders) are paying for e-waste management when disposing the equipment.
- **Ghana:** the current e-waste bill is proposing a model where financial responsibility is allocated to Producers but the organizational role remains with the government.
- **South Africa:** a new plan is developed; it is based on EPR, with producers paying e-waste management costs to a central body that is subsequently transferring the money to a producer responsibility organization (PRO) handling the payment of take back activities.
- **Kenya:** the current e-waste bill is proposing a model, based on EPR, where producers pay net treatment costs directly to recyclers.

2.1 EUROPEAN UNION AND NATIONAL TRANSPOSITIONS

The EU Waste Electrical and Electronic Equipment (WEEE) Directive (2002/96/EC now replaced by 2012/19/EU) was one of the first massive implementations of the EPR principle for e-waste management in the world. When it was originally published (February 2003) and later enforced (from August 2005 onwards, except delays in some Member States) only few countries in the world had legislation on e-waste in place (f.i. Switzerland, Japan, few European countries, few States in the US like California and Massachusetts).

For some EU Member States, the transposition of the Directive into national legislation, and the development of take-back schemes and recycling infrastructure were relatively easy. They already had legislation and recycling infrastructures in place prior to the Directive (f.i. Austria, Belgium, Denmark, Sweden, Luxembourg). In other cases the transposition process was more difficult and national debate took longer. The UK finally transposed the WEEE Directive only in December 2006.

Despite the legal text of the WEEE Directive each Member state had the opportunity to go beyond the Directive requirements when transposing the legal text in its own legislation: this is why across the EU the actual implementation of the WEEE Directive is in many cases different.

Variations are mainly linked to the practical arrangements within the national management framework and agreements between stakeholders. Variety of approaches reflecting different social and economic conditions of EU Member States give anyway the opportunity to identify some “smart” solutions or approaches that proved to be more effective and efficient than others in the implementation of the principles laid down in the Directive.

2.1.1 SCOPE & PROVISIONS OF LEGISLATION

The WEEE Directive has one of the broadest scopes worldwide, particularly in its new version (2012/19/EU): from 15 August 2018 the so-called “open-scope” will be enacted. In its original version (2002/96/EC) the Directive covered electrical and electronic products (EEE) defined as:

Equipment which is dependent on electric currents or electromagnetic fields in order to work properly and equipment for the generation, transfer and measurement of such currents and fields falling under the categories set out in Annex IA and designed for use with a voltage rating not exceeding 1000 Volt for alternating current and 1500 Volt for direct current

Annex 1A of the Directive specified the product categories covered: (1) large household appliances, (2) small household appliances, (3) IT and telecommunications equipment, (4) consumer equipment, (5) lighting equipment, (6) electrical and electronic tools (with the exception of large-scale stationary industrial tools), (7) toys, leisure and sports equipment, (8) medical devices (with the exception of all implanted and infected products), (9) monitoring and control instruments and (10) automatic dispensers. Annex 1B provided a non-exhaustive list of examples of products covered.

With the transition to the “open-scope” the EEE covered by the Directive are no longer clustered according to the product categories, but according to “collection categories” or “waste streams”.

Such a transition ensures better monitoring and allocation of responsibilities and provisions of the Directive’s articles, particularly allocation of costs and control of recycling and recovering performances.

The new clustering is closer to the actual waste management operations, as discarded appliances were and are collected not according to the 10 products categories but rather according to individual waste streams, depending on the treatment technologies adopted and treatment requirements.

Difficulties arise when in a single product category products belonging to different waste streams are clustered: this was the case for consumer equipment (former category 4), including CRT and Flat Panel Displays televisions (with specific recovery targets and technologies used) and other consumer electronic products (having different recovery targets and technologies adopted): CRT and FPD were and are collected in a specific waste stream compared to other

consumer electronic products, with totally different technology used for treatment and logistics and treatment costs.

With the new Directive (2012/19/EU) the categories of products changed into: (1) temperature exchange equipment, (2) screens, monitors, and equipment containing screens having a surface greater than 100 cm², (3) lamps, (4), large equipment, (5) small equipment and (6) small IT and telecommunication equipment. Those categories are reflecting actual collection treatment streams across Europe.

WEEE Directive legal provisions embrace a set of different topics, tackling important elements of the overall e-waste management. The following paragraphs briefly summarize them, considering the new WEEE Directive legal text (2012/19/EU):

- **Separate collection** (Article 5). Is responsibility of Member State to set-up separate collection systems for household WEEE. Different obligations are stated for household (B2C) or non-household (B2B) streams. For B2C streams Member States should ensure final users are able to return WEEE free of charge.
Retailers should provide a take back service for final users on “old-for-new basis” (thus, when a consumer buys a new equivalent equipment, should return to the retailer free of charge the old one, except for small WEE that can now be returned for free to any retailer having a sales area greater than 400 m²).
Producers could organize alternative systems, individually or collectively, in order to ensure free of charge take back from household final users.
For B2B waste streams Producers or third parties acting on their behalf provide for separate collections (as usually not going through the collection infrastructures available for citizens).
All WEEE collected should be transported to authorized treatment facilities, in order to maximise the reuse of whole appliances, components or the recovery of materials, according to treatments and recovery requirements settled in articles 8 the Directive.
- **Treatment requirements** (Article 8). All appliances collected should be treated in authorized facilities according to Best Available Techniques (BAT) in order to ensure high level of environmental and human health protection.
Member States are also encouraged to develop minimum treatment standards to be enforced: currently EU standardization body (CENELEC) is developing collection, logistics and treatment standards for different waste streams.
The directive itself contains minimum selective treatment for specific appliances and components (Annex VII) and details regarding minimum technical requirements for storage of WEEE and sites where treatment is occurring (Annex VIII).
- **Recovery targets** (Article 11). Paramount for achievement of environmental benefits once WEEE is collected and treated is to ensure recycling and recovery targets are achieved.
Member State should ensure producers achieve specific targets in recovery and reuse or recycling. Those targets are weight-based targets and depend on different type of equipment (and from August 2018 onwards on waste streams).

- **Financing mechanism** (Articles 12 and 13). Financing mechanism proved to be challenging and in some cases over-complicated as depending on two criteria (Table 3): type of waste stream (household versus non-household) and the time appliances have been placed on market (“historical waste”, arising from products placed on the market prior entry into force of the Directive and “new waste”, arising from appliances placed on the market after the Directive entered into force). Both the criteria resulted not straightforward to apply and in some cases grey areas still exist, particularly when it comes to distinction between household and non-household and historical versus new waste:
 - Household stream (Article 12)

Member State shall ensure Producers finance management of WEEE arising from appliances put on market after 13th August 2005 (new WEEE) on the basis of EPR principle.

Producers are free to choose an individual approach (thus every producer is allowed to set up an own Product Recovery Network to collect and treat his own products discarded) or a collective one (thus joining a system together with other producers in order to ensure the proper management of discarded products).

Producers should provide at least for the financing of the collection, treatment, recovery and environmentally sound disposal, according to the wording of WEEE directive.

Every producer, when placing new appliances on market should provide a financial guarantee for management of future waste arising from those appliances, when discarded; guarantee might be in a form of participation in a compliance scheme, an insurance or a blocked bank account.

Financing of management of WEEE arising from appliances placed on market before 13th August 2005 (historical WEEE), thus out of the EPR principle, should be ensured by Producers collectively present on the market when costs related to the management of those WEEE arise.

In the original WEEE Directive (2002/96/EC) Producers were allowed to show to customers costs incurred in the management of those historical WEEE by means of a Visible Fee, to be added on sale price; financing of Historical WEEE was in practice ensured by consumers when Visible Fee was used.

In the new WEEE Directive (2012/19/EU) Member States may require Producers to show purchasers the cost for collection and treatment of appliances.

Again, like for the Visible Fee in the past, such provision might shift, in practice the financing responsibility from Producers to consumers.
 - Waste from others than private households (Article 13)

Member State shall ensure Producers finance management of WEEE arising from appliances placed on market after 13th August 2005 (new WEEE) on the basis of EPR principle.

Anyway Producers are allowed to conclude different financial agreements with their customers when selling new appliances concerning the financing of management of WEEE.

No financial guarantees need to be provided for non-household appliances placed on market.

Financing of management of WEEE arising from appliances placed on market before 13th August 2005 (historical WEEE), thus out of the EPR principle, should be ensured by Producers when replacing an old appliance with a new one only if appliances are “equivalent”.

Otherwise is up to the holder of the appliance to be discarded. In the new WEEE Directive (2012/19/EU) the opportunity of showing to customers the actual costs for WEEE management is also foreseen, as for household streams.

	Historical WEEE (ante 13-08-2005)	New WEEE (post 13-08-2005)
Household WEEE (B2C)	<p>EPR (Collective approach)</p> <p>Option to show customers costs incurred (Visible Fee in old WEEE Directive) till 2011/2013.</p> <p>Financial Guarantees not required</p>	<p>EPR (Individual or Collective approach allowed)</p> <p>(New) Option to show customers costs incurred</p> <p>Financial Guarantees required</p>
Non-Household WEEE (B2B)	<p>EPR for equivalent appliances, Customer responsibility for non-equivalent appliances</p> <p>(New) Option to show customers costs incurred</p> <p>Financial Guarantees not required</p>	<p>EPR (Different agreement with customers allowed)</p> <p>(New) Option to show customers costs incurred</p> <p>Financial Guarantees not required</p>

Table 3: Overview of financing mechanism foreseen by WEEE Directive. Provisions introduced by the new WEEE Directive are indicated with (New).

- **Information & Reporting requirements** (Articles 14, 15 and 16). Member States should ensure that consumers and waste holders in general are aware of separate collection requirements and systems in place to properly dispose of WEEE. The Directive requests also producers to make available to treatment facilities, information on components and materials and location of dangerous substances. Fundamental is the provision on the set up of a register of producers: this to ensure control over obliged parties for financing but also to keep records of EEE placed on national markets, WEEE collected, treated and recovered or recycled.

2.1.2 PRE-REQUISITES & PECULIARITIES OF THE FINANCING MODEL

One fundamental success factor of the implementation of WEEE Directive across Europe, with a coverage of more than half a billion citizens and more than 2.5 million tons of e-waste officially reported as collected and treated in 2012 is the surrounding legislative and organizational framework and in particular:

- Citizens and consumers are already familiar with important principles for e-waste management from the management of other waste streams, e.g. the separate collection of municipal solid waste, packaging and batteries, which are also tackled by a series of different waste legislations. When they decide to discard appliances WEEE is handed over to logistics providers and treated by companies acting on behalf of producers, or by other waste management operators authorized.
- General collection and treatment infrastructures are nowadays in place in the majority of Member States. Development of waste management infrastructures spanned over past decades, with different speed in different regions (slower in Eastern and Southern EU). The development of specific e-waste treatment technologies is an on-going process. It is triggered by the challenges of new products in the waste streams and by the research of increasing effectiveness in material recovery, mainly economic-driven.
- E-waste was already handled in many EU countries even prior the entry into force of the WEEE Directive. In some countries under a regulated framework, sometimes with limited scope or product coverage. In many cases WEEE were mainly handled as metal scrap; in such cases, for waste collected in municipal solid waste, financing was basically relying on the local/municipal taxes or waste management fees. Handling of WEEE as metal scrap (which is in some cases still happening across EU) was also reflecting the material composition of older, mainly metal dominated appliances. In recent years, the average composition of EEE changed: more use of plastics and increase of the share of “electronics” parts, embracing new challenges in waste management, as already highlighted.

- From an organizational perspective, one of the biggest changes introduced by the WEEE Directive in the EU waste management framework was the opportunity for obliged parties (the producers) to comply with provisions in different ways (both collectively or individually). The introduction of this organizational freedom created a regulated competition in the market. In the great majority of EU Member States, Producers created compliances schemes or contracted service providers to take care of the logistics and treatment obligations.
- Compliance Schemes are usually requesting different service providers (logistics companies and treatment plants) quotes for activities on a competitive/bidding basis. Usually they stipulate annual contracts with a network of providers ensuring geographical coverage for the different waste streams. Service providers are paid on the basis of WEEE collected and treated on behalf of the Compliance Scheme.
- Figure 3 and Figure 4 below compare the ranges (min-max) of technical costs across the EU in 2005 before the WEEE Directive was implemented, and in 2011 when economies of scale and cost optimization was achieved. Differences (min-max) are mainly linked to the different economic conditions of different Member States. Averages tend anyway to be closer to the min for countries with longer history in e-waste collection and treatment.

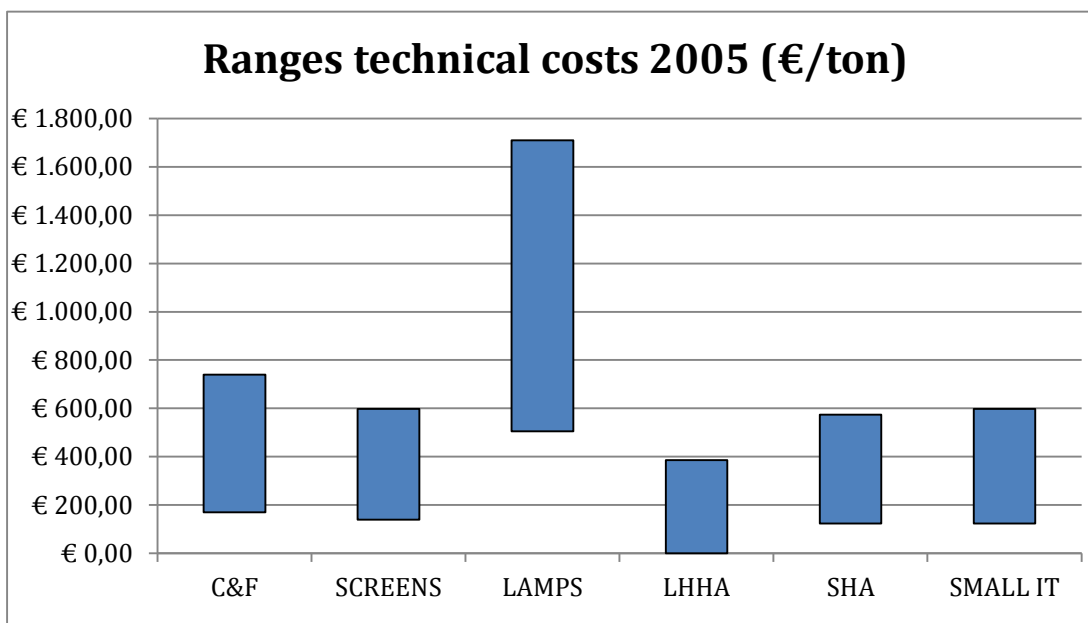

Figure 3: Technical costs in 2005 across EU.

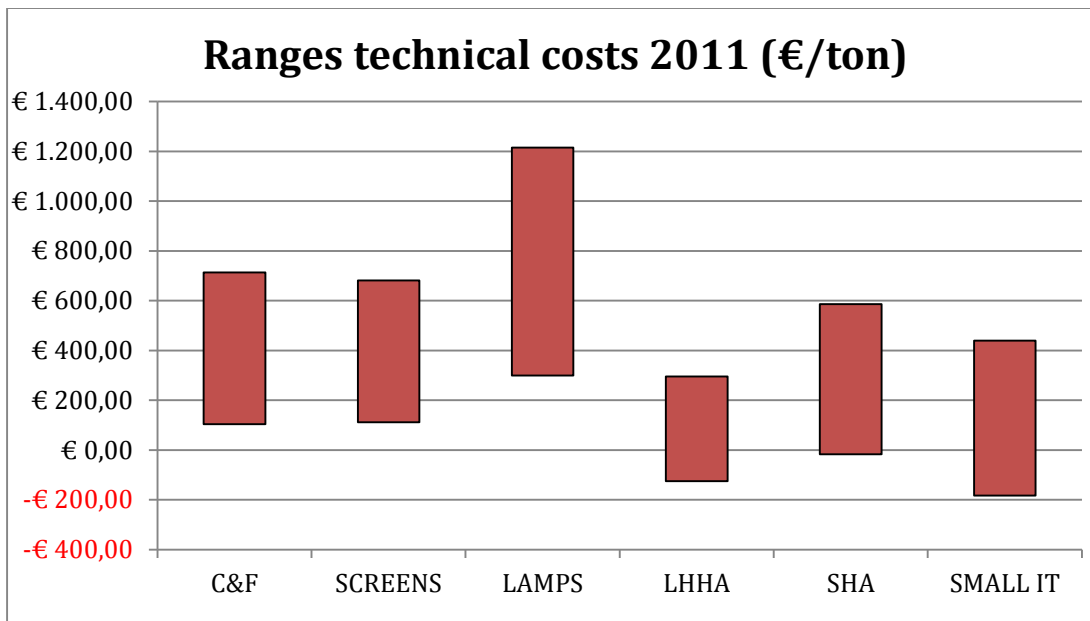

Figure 4: Technical costs in 2011 across EU.

The way Compliance Schemes are charging their members (Producers) might vary from scheme to scheme but the sum of annual costs for WEEE handled on behalf of the Scheme by the contracted service providers need to be covered (in addition to the running costs of the Scheme itself, like salaries of the employees and other overhead).

This means that a certain buffer is created, and in the great majority of cases the fees paid by Producers to Compliance Schemes are not directly reflecting the technical costs for e-waste collection and treatment, but include also other costs related to the functioning of the Compliance Scheme, which in some cases might cover part of the “framework costs” highlighted in Table 4.

2.1.3 ACTIVITIES FINANCED UNDER E-WASTE LEGISLATION

	Stakeholder	Notes & Examples
Access to waste	Free of charge. Producers might reimburse	<ul style="list-style-type: none"> Consumers are disposing for free in existing collection infrastructures (municipalities & retailers or other dedicated ones). Infrastructure costs (set-up + running) are borne by municipalities or retailers. In some cases Producers or their Compliance Scheme reimburse them for a quota of operational costs (f.i. Netherlands, Belgium), or reward effective collection performances (f.i. Italy)
	Usually Producers	<ul style="list-style-type: none"> Service providers (logistics companies contracted by Producers/Compliance Schemes) own containers. Renting price is usually included in the contractual agreement with Producers/Compliance Schemes. In some cases Compliance Schemes purchased containers (f.i. Italy)
	Producers	<ul style="list-style-type: none"> Service providers (logistics companies contracted by Producers/Compliance Schemes) contractually agree on the price for services provided.
	Producers	<ul style="list-style-type: none"> Treatment plants (contracted by Producers/Compliance Schemes) contractually agree on the price for services provided (net treatment cost, per waste stream usually, positive or negative) in a competitive environment.
Enforcement	Government	<ul style="list-style-type: none"> Enforcement is the responsibility of central government and dedicated agencies (having also the power to raise fines).
Audit	Government Producers (Compliance Schemes) running own audits	<ul style="list-style-type: none"> Audits, particularly linked with issuing and monitoring of waste permit provisions belongs to responsibilities and roles of central government and dedicated agencies (having also the power to raise fines). In many cases Producers/Compliance Schemes are voluntarily carrying out audits (minimum annually) on their contracted suppliers to enforce contractual provisions and monitor environmental performances according to applicable standards (f.i. WEEE Forum WEEELabex)
	Governments Producers (Compliance Schemes) voluntarily	<ul style="list-style-type: none"> Awareness raising is usually the responsibility of Member States. In Austria the clearinghouse is responsible for setting a fee for the costs incurred by municipalities or associations of municipalities to ensure the harmonised information of final consumers as a function of the number of residents; costs are born by Compliance Schemes according to market share. For 2013, it was 0.055 €/inhabitant (approx. 460,000 Euro) In many cases Compliance Schemes across EU are organizing anyway dedicated awareness raising campaigns.
Guarantees	Producers, if requested	<ul style="list-style-type: none"> According to the majority of national transpositions of the WEEE Directive, joining a compliance scheme represents an exemption criteria for providing financial guarantees in respect of new appliances placed on the market.
Other costs	N.A.	

Table 4: Allocation of financial responsibilities (technical costs and framework costs) under the WEEE Directive (incl. some national transpositions examples)¹

¹ For detailed information on one transposition example of the WEEE Directive see: Otmar Deubzer, United Nations University: E-waste Management in Germany; report from 20 July 2011 commissioned by the Gesellschaft

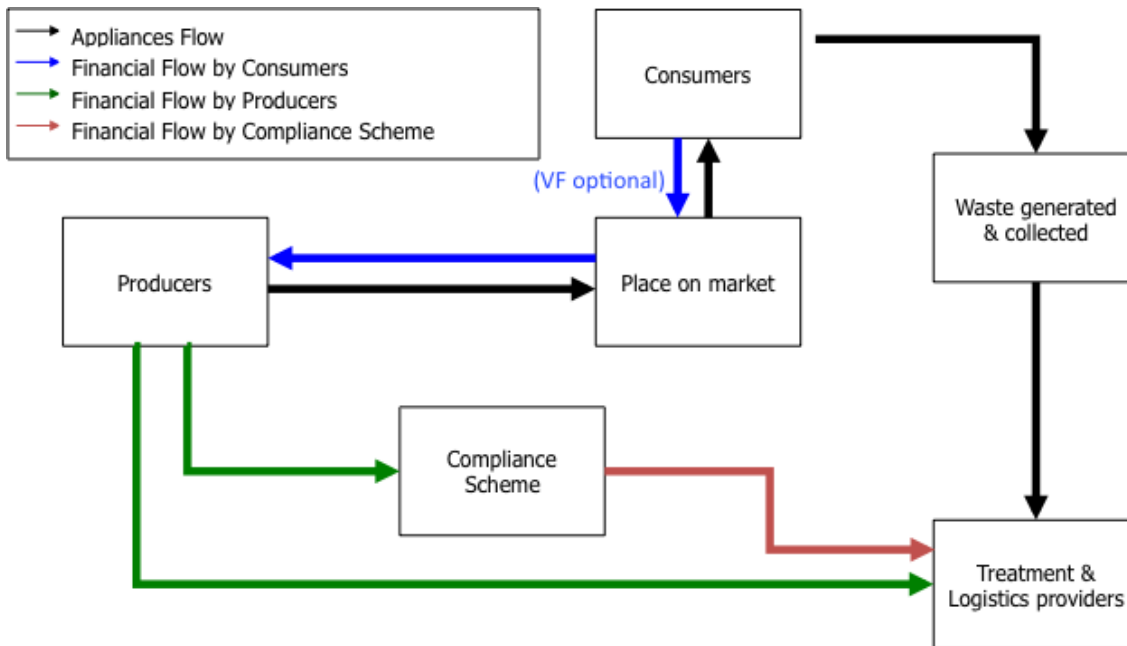

Figure 5: Financial and physical flow in the WEEE Directive.

2.2 CALIFORNIA

The **Electronic Waste Recycling Act (EWRA)** was published in September 2003 (SB 20/2003, amended by SB 50/2004).

The purpose of the original act, consisting of less than 10 lines of legal text, was to ensure funds were available to assist local authorities to collect and recycle e-waste.

One year later the Act was complemented with detailed provisions on the organizational and financial aspects.

2.2.1 SCOPE & PROVISIONS OF LEGISLATION

One of the main differences of the EWRA compared with the EU WEEE Directive is the scope: **only a limited number of products is covered** by legislative provisions. The list includes: Cathode Ray Tube (CRT) containing devices, CRTs, Computer CRT monitors, laptop computers with liquid crystal display (LCD), LCD containing desktop monitors, CRT televisions, LCD televisions, plasma televisions and portable DVD players with LCD screens. In 2004, mobile phones have also been included, but with a different financing model.

für Internationale Zusammenarbeit (GIZ); <http://isp.unu.edu/publications/scycle/files/ewaste-management-in-germany.pdf>, or http://ec.europa.eu/environment/waste/weee/links_en.htm

The second outstanding difference is the financing model adopted. EWRA is not based on the EPR principle, but consumers are financing collection and recycling paying a fee upon purchase of a new appliance, which is in the scope of the legislation.

From 1st January 2005, when purchasing a new appliance consumers are requested to pay a fee, varying from 6\$ to 10\$ when initially adopted (reduced to 3\$ to 5\$² from 2013 onwards), depending on the product. Collected fees are deposited in an Electronic Waste Recovery and Recycling Account managed by the State of California (Board of Equalization - BOE) and are used to pay authorized³ collectors and recyclers.

Retailers might retain 3 % of the fee collected as reimbursement for the cost associated with collection and remit of the fee (quarterly) to the BOE. For mobile phones no payment of the fee is requested but retailers must have in place, and promote, a system for accepting and collecting mobile phones for reuse, recycling or proper disposal at no cost to the consumers.

The basic principle behind EWRA was to (i) foster the development of recycling opportunities and (ii) offset the cost of properly managing e-waste from local authorities. EWRA (SB50/2004) also contains other relevant provisions that are partially amending the general waste management legislations or addressing specific e-waste management aspects:

- **Separate collection: approved collectors**, listed and available for public consultation, carry out collection of e-waste (to date they are more than 500); **consumers are requested to drop-off** their e-waste at their premises but also special events and **door-to-door pick-up** to collect e-waste might be organized by collectors. **Collectors are receiving compensation** from BOE, based **on the amount of e-waste collected**.
- **Treatment and export: treatment** need to be carried out **by licensed operators** that are reimbursed for the treatment operations by the BOE. To date the number of approved treatment operators is more than 40.
Specific provisions on export of electronic waste are indicated, while no specific requirements on recovery and recycling targets are explicitly mentioned. Recyclers are also receiving compensation from BOE.
- **Financing: Retailers are collecting the recycling fee from consumers** and are transmitting quarterly to the BOE the funds collected (eventually **retaining 3 % as reimbursement for their costs**).
BOE is responsible for establishing the recycling fee for different products and the compensation for authorized collectors and recyclers.
Operators (collectors or recyclers) that intend to be part of the system need to submit an application and obtain the authorization beforehand.
The compensation is fixed. It is based on calculations of the BOE and reflects the collection and net treatment costs.

² State of California: official Electronic Waste Recycling Fee http://www.boe.ca.gov/sptaxprog/tax_rates_stfd.htm#6

³ State of California: Directory of Approved Collectors and Recyclers of Covered Electronic Waste <http://www.calrecycle.ca.gov/Electronics/Reports/default.aspx>

All operators are annually requested to carefully report⁴ on the costs incurred when conducting collection and recycling activities to allow BOE to update the compensation fee.

The current compensation fee was initially set in 2005 to 0.20 \$/pound (approx. 445 \$/t) for collection and 0.28 \$/pound (622 \$/t) for treatment.

Current compensation fee is set to 0.44 \$/pound (978 \$/t) for both collection and treatment which are paid to recyclers that need to compensate collectors with a minimum of 0.18 \$/pound (400 \$/t) but without upper limit.

- **Information & reporting:** manufacturers are requested to notify retailers which of the products they are placing on the market are covered by the legislation. They are also requested to provide information to consumers on recycling opportunities. One of the key reporting requirements for **manufacturers** is to **annually report⁵ on devices sold** in California: the report shall include, in particular, sales data, data on hazardous substances contained, estimation of recyclable content information on design for recycling aspects and the list of all the retailers that have been notified.

2.2.2 PRE-REQUISITES & PECULIARITIES OF THE FINANCING MODEL

Like in the case of the WEEE Directive, EWRA has been published in the wider context of waste management regulations of California. I

Interestingly in the original Act **one element triggering the establishment of the program was the “lack of the infrastructure needed to provide for the convenient and affordable collection, refurbishment, processing, and recycling of electronic wastes”** and the mobilization of *“funds to assist cities, counties, and recyclers of electronic wastes in developing programs to safely collect and recycle the hazardous materials contained in electronic wastes”* as stated in the legal text of the Act itself.

Considering the peculiarity of the financing model (establishment of a fixed compensation for collection and treatment activities by approved operator) the following aspects need to be taken into account:

- **Collectors and recyclers have a direct incentive to maximize the amount of material they process:** the more they process, the more compensation they get. Such an element **could be of help in the start-up phase** of e-waste recycling industry, **but might show limitations in the medium term.** There is indeed **no real incentive to cost-effectiveness** in the system.

⁴ State of California: Collector and Recycler Net Cost Reporting, retrievable from <http://www.calrecycle.ca.gov/Electronics/Act2003/Recovery/NetCost/Default.htm>

⁵ State of California: form to be filled annually by manufacturer to report on appliances sold <http://www.calrecycle.ca.gov/Electronics/Forms/CalRecycle242.doc>

Even if collectors or recyclers invest in more effective processes to maximize the quantity or the value of the fractions recovered and achieve economies of scale **the compensation they receive is fixed.**

The impact of their operations' improvement on the annual calculation of fees by BOE might be minimal as the net treatment costs are calculated on the basis of the information received by all the recyclers and collectors⁶.

In California **recycling fees have not decreased over the last 10 years** despite the achievement of economies of scale and increased quantities processed by the system.

Figure 6 shows how in the last 10 years the recycling fees for different products has not been influenced by the increase of volume processed and in 2008 and 2009 they increased despite the amount processed, compared to previous year, was slightly decreasing.

The reduction of recycling fees paid by Consumers **from 2013 onwards** is **mainly linked to a different allocation of the reserves cumulated in previous years** rather than to more cost-efficient collection and treatment.

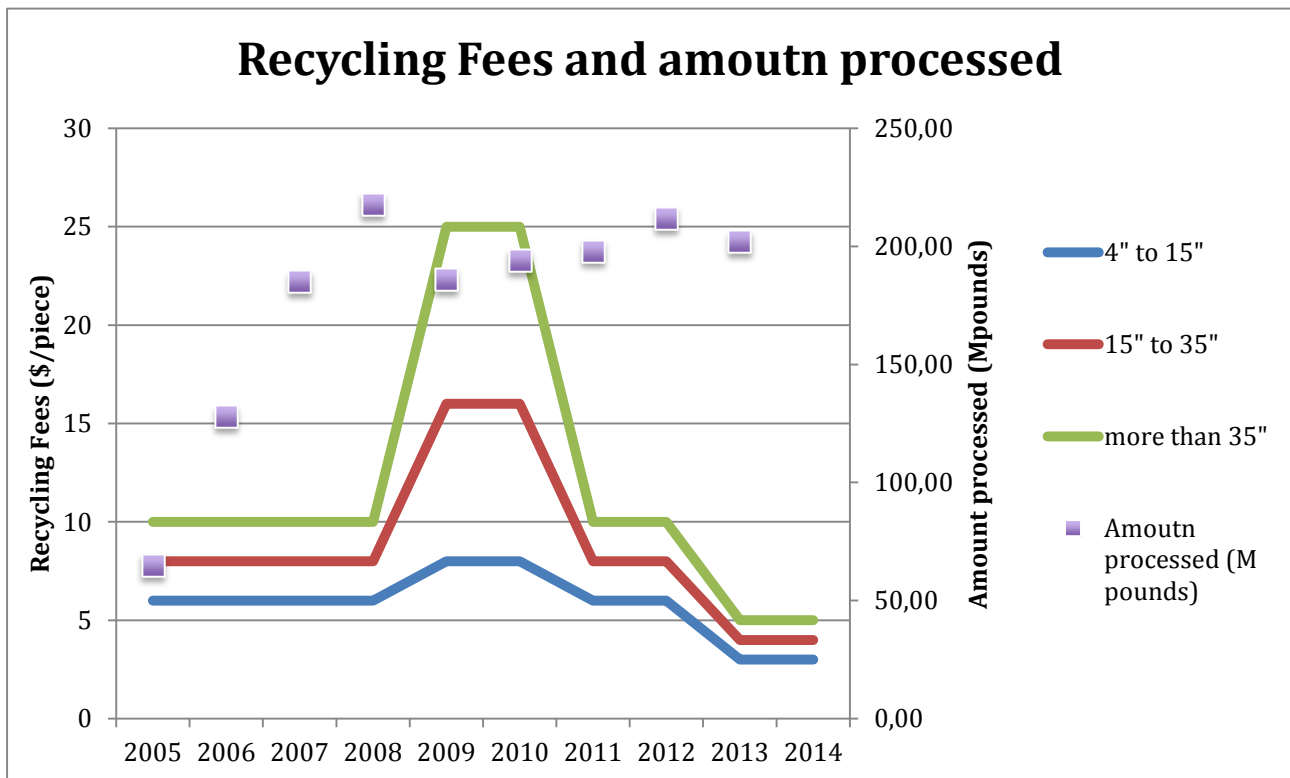

Figure 6: Performances of the Californian system and recycling fees.

⁶ State of California: form to be filled for annual declaration of net cost by collectors and recyclers <http://www.calrecycle.ca.gov/Electronics/Act2003/Recovery/NetCost/Default.htm>

Similarly the benefits of cost-effectiveness efforts at operational level are not directly reflected in the compensation paid by BOE, as these fees are calculated centrally for all recyclers.

Over the last 10 years the overall compensation remained practically un-changed at around 0.50 \$/pound (1.110 \$/t).

Comparing the 2008-2011 period in Europe, the technical costs decreased as long as the system increased the collected amount and optimization in the entire market was achieved, as shown in Figure 7: technical costs paid in California for collection and treatment of CRT appliances are compared for 2008-2011 with Italian market, during the start-up of the system.

As the figure shows, the optimization of the system, progressive increase of quantities treated and the competition among collectors and recyclers lead to decrease in the technical costs.

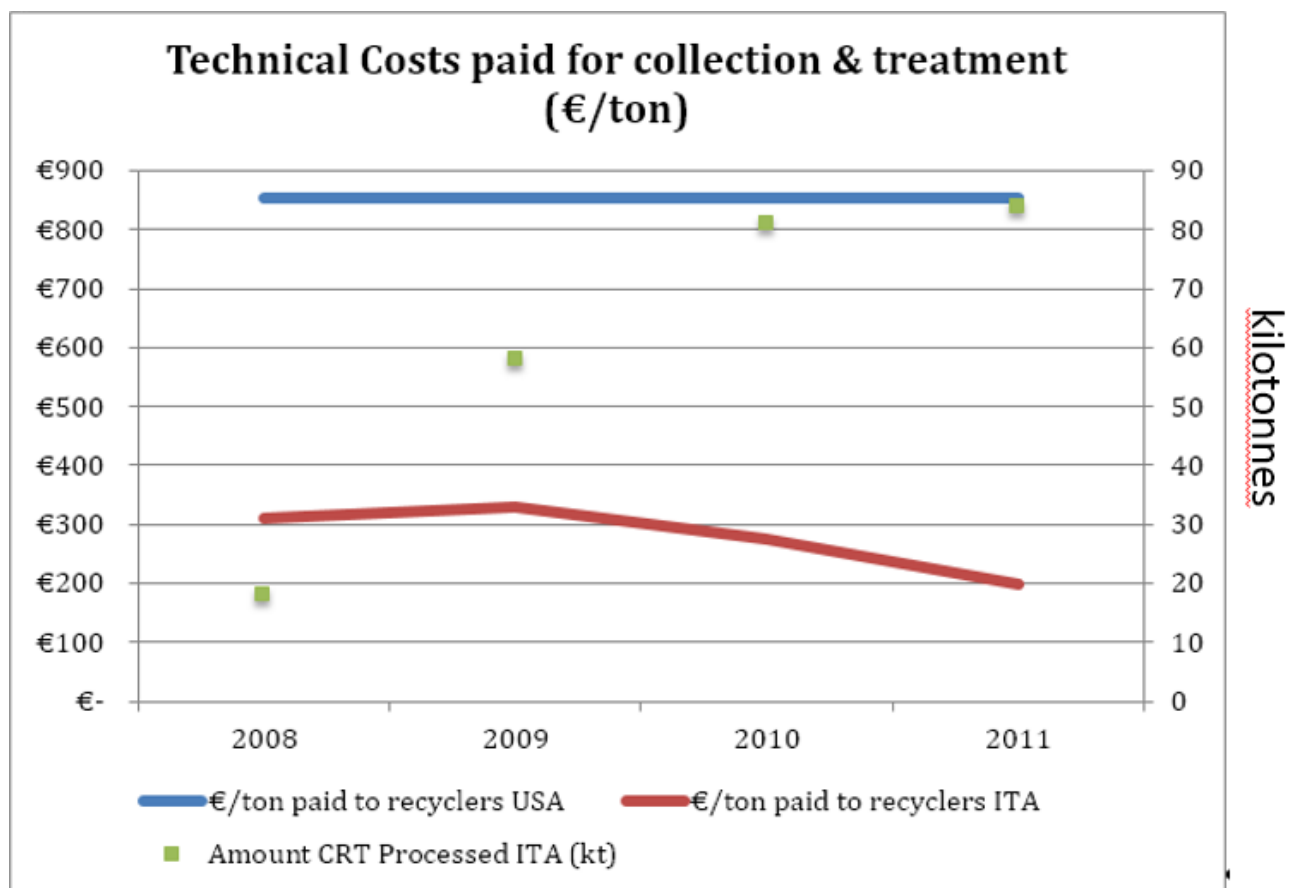

Figure 7: Comparison of technical costs (collection plus recycling) in California and Italy in 2008-2011.

2.2.3 ACTIVITIES FINANCED UNDER E-WASTE LEGISLATION

	Stakeholder	Notes & Examples
Access to waste	N.A.	<ul style="list-style-type: none"> Consumers are disposing their e-waste for free. E-waste is handed-over to authorized collectors or picked up during collection events organized by local collectors.
Containers	Consumers	<ul style="list-style-type: none"> Collectors are reimbursed for the costs incurred in operating a free and convenient system for collecting. Initially by BOE, nowadays by treatment operators.
Transport	Consumers	<ul style="list-style-type: none"> Collectors are reimbursed for the transportation to approved treatment facilities. Initially directly by the BOE, nowadays by treatment operators
Treatment	Consumers	<ul style="list-style-type: none"> Recyclers are reimbursed by the BOE for the net cost of receiving, processing and recycling e-waste received by approved collectors. Nowadays they have also to reimburse approved collectors.
Enforcement	Consumer	<ul style="list-style-type: none"> BOE sets fees in order to administer and enforce the program.
Audit	N.A.	<ul style="list-style-type: none"> Not specified in the bill.
Awareness Raising	Consumers Producers	<ul style="list-style-type: none"> BOE sets fees in order to promote the program. Manufacturers are requested to provide information to consumers.
Guarantees	N.A.	<ul style="list-style-type: none"> Not needed as consumers are paying the fee upon purchase of new appliances. The BOE set the fees to keep a reserve not exceeding 5% of the total amount on the fund account. In 2012 fees has been substantially reduced to better manage fund reserves.
Other costs	N.A.	<ul style="list-style-type: none"> Not specified in the bill.

Table 5: Allocation of financial responsibilities (technical costs and framework costs) in California.

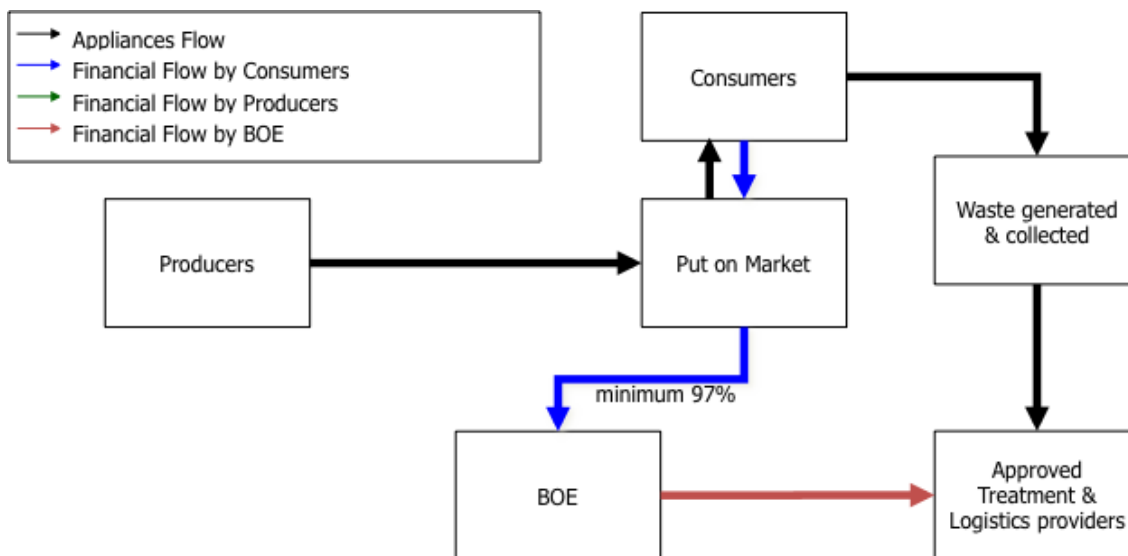

Figure 8: Financial and physical flows in California.

2.3 JAPAN

In Japan consumers (or better said “waste-holders”) are, for the products covered by e-waste legislation, requested to pay the necessary fees associated with the transport and recycling of the appliance.

Japan is the only country in the world to implement such a system for e-waste management and as such represents also an interesting model to analyse more in detail.

Models where waste holders are paying for waste disposal are quite common in non-household waste in Europe and normally is the basis of general municipal solid waste management usually paid by tax-payers.

The Japanese model has been in operation since 1998 and is one of the oldest legally binding systems for e-waste.

2.3.1 SCOPE & PROVISIONS OF LEGISLATION

There are 3 main policy bills for different products – some with compulsory recycling targets, with other products falling under voluntary initiatives.

- In 1991 the “law for promotion of effective utilization of resources” was initially issued; it introduced five concepts: (i) prevention of waste management by eco-design, (ii) extended life of electronics, (iii) design for recycling, (iv) reduction of recycling cost and (v) information sharing mechanism. PCs were covered under this law and recycling costs were internalized in the cost of purchase.
- In 1998 the “law for the recycling of specific kinds of home appliances” was published, covering a wider set of products (TV, air conditioners, washing machines, dryers and refrigerator).

- Finally in 2013 the “law for recycling of small electronic appliances” was developed and entered into force targeting mobile phones and small IT devices in particular.

The fundamentals of the Japanese system are anyway contained in the law for recycling of home appliances entered into force in 2001:

- **Collection** (articles 6, 9-16, 29-31): consumers and business users are requested to dispose e-waste generated through retailers or municipalities. There were 369 collecting stations (as of April 2014) across Japan where retailers could drop off e-waste collected from consumers or end users. Manufacturers might also be requested to pick up e-waste directly from waste holders.
- **Treatment** (articles 18,22, 24): e-waste collected should be transferred to authorized recycling plants. Manufactures or contracted recyclers have to fulfil their recycling obligations, achieving compulsory targets. Forty-nine designated e-waste recycling facilities nowadays exist in Japan: independent operators run 33 while 16 were built up and are currently managed by a group of manufacturers.
- **Financing** (articles 6, 11-14, 19-21): consumers (or waste holders) are requested to pay a fee upon disposal of the e-waste.
 Municipalities/retailers or manufacturers, depending on the entity accepting the e-waste from the consumer, decide fees for different products covered by legislation. Fees need anyway to be publicly announced and competent ministries might check if the amount requested is reasonable and reflecting the costs for proper collection and recycling.
 Actually the fees vary between US\$ 27 and US\$ 65 depending on the type of appliance.
- **Information & reporting** (articles 43): amounts collected and recycled need to be traced by entities responsible (retailers, manufacturers) and reported to competent authorities.

2.3.2 PRE-REQUISITES & PECULIARITIES OF THE FINANCING MODEL

In Japan the development of the model for e-waste recycling followed a common pattern for industrial waste and in some cases for household waste as well:

- Waste holders are responsible for environmentally sound disposal of the waste; this includes the hand over to an appropriate collection (or recycling infrastructure) paying the corresponding fee. Fees are calculated on the basis of net treatment costs and specific collection costs on a competitive market scenario.
- Two different approaches can be identified: some producers comply contracting the existing waste management operators. They tried to minimize recycling costs through economies of scale.
 Others decided to build own recycling plants and attempted to reduce total costs by adopting efficient logistics systems also using transport company warehouses as collection sites.

This creates a competitive offer of recycling services for retailers and consumers: collection sites are managed separately and retailers may not choose their nearest collection site if costs are lower elsewhere.

2.3.3 ACTIVITIES FINANCED UNDER E-WASTE LEGISLATION

Table 6 lists the activities financed and the stakeholders responsible for financing under the current e-waste legislation.

	Stakeholder	Notes & Examples
Access to waste	N.A.	<ul style="list-style-type: none"> Consumers (or waste holders) are requested to pay when disposing e-waste. So access to waste has actually a negative value (is the income for collectors and recyclers).
Containers	Waste holders (consumers)	<ul style="list-style-type: none"> Cost is included in the fees paid.
Transport	Waste holders (consumers)	<ul style="list-style-type: none"> Cost is included in the fees paid.
Treatment	Waste holders (consumers)	<ul style="list-style-type: none"> Cost is included in the fees paid.
Enforcement	N.A.	
Audit	N.A.	
Awareness Raising	Government	<ul style="list-style-type: none"> Government is responsible to promote the use of collection and recycling infrastructures by consumers and waste holders, increase education and public awareness-
Guarantees	N.A.	
Other costs	N.A.	

Table 6: Allocation of financial responsibilities incl. technical costs and framework costs in Japan.

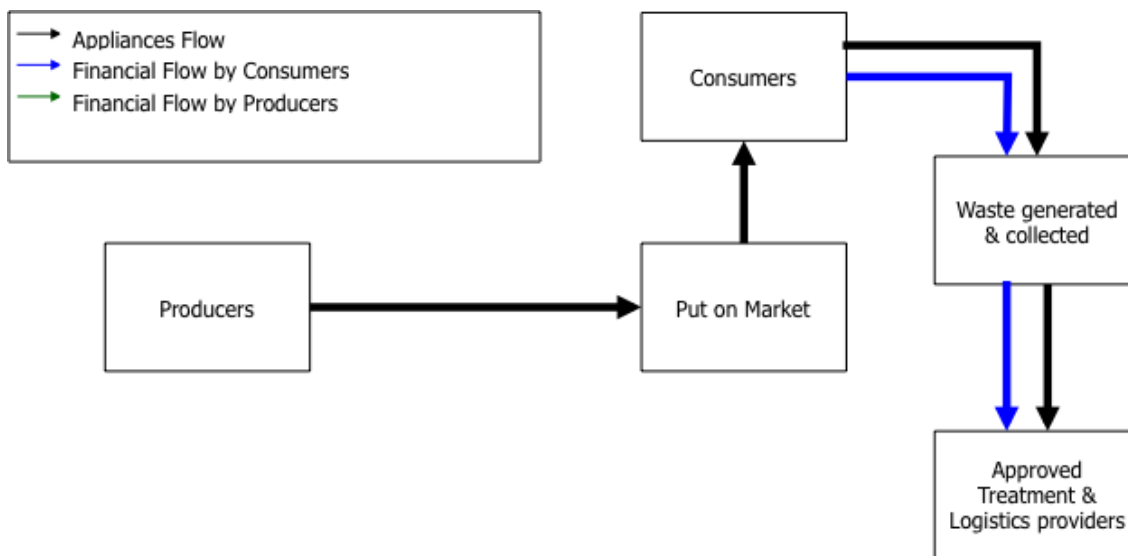

Figure 9: Financial and physical flows in Japan.

2.4 GHANA

Ghana has not yet approved the policy bill on e-waste management despite since 2011 several versions have been proposed and distributed for open consultations.

Nevertheless, the model foreseen in the latest bill is anyway interesting to describe as it represents a unique approach: Producers are requested to bear only financial responsibility while the government is fully retaining organizational responsibility over e-waste management.

2.4.1 SCOPE & PROVISIONS OF LEGISLATION

The scope of the proposed bill embraces almost all 10 products categories covered by the WEEE Directive).

The e-waste bill is included in a wider bill on hazardous waste control and management, focusing in the first section on the transboundary shipments and general waste management provisions.

The second section of the bill sets requirements on e-waste management, in particular:

- **Collection** (articles 30, 31, 44, 45, 48, 49): municipalities are responsible to designate collection points where producers are requested to provide storage containers.

Collection facilities need to be approved by the Environmental Protection Agency (Agency in the following) and e-waste need to be disposed of at designated collection points or taken back by producers.

- **Treatment** (articles 42, 43, 44): The Agency is responsible for management of an e-waste recycling plant to be set up.
The Agency is also responsible for transportation of e-waste from collection points to the plant and for maintenance of collection infrastructure (20 % of the revenues of the plant should be allocated for this purpose).
Other operators or private persons might apply for treatment plant licenses to be approved by the Agency.
The approval of licences is also subject to a submission of a business plan, which includes the availability of collection facilities across the country.
- **Financing** (articles 28, 32-41): financing of e-waste management including technical but also some framework and set-up costs is based on fee producers (manufacturers and importers) have to pay to the Ghana Revenue Authority.
Fees are paid prior the import of electronic equipment covered by the legislation.
No specific provisions on timing of payment are defined for manufacturers.
Fees vary between 0.1 and 5 GHc/product (0.03 and 1.25 €/product) and are building up an “Electronic Waste Recycling Fund”.
The Fund is not only supposed to cover technical cost of e-waste management, but also to (i) set up and maintain recycling plants, (ii) research and (iii) raise awareness.
Parliament might allocate other financial sources for the Fund.
It is not specified in the bill whether the recycling fees reimburse also treatment costs borne by private plants.
- **Information & reporting** (articles 28, 29): manufacturers and importers should register with the Agency.
The purpose of registration is linked to the financing obligations.

2.4.2 PRE-REQUISITES & PECULIARITIES OF THE FINANCING MODEL

The model foreseen by Ghana is quite unique in the context of e-waste management. Some important elements need to be highlighted:

- One of the fundamental elements in the bill is the creation and maintenance of formal recycling infrastructures in the country through the levy of recycling fees.

Set-up costs for collection and treatment infrastructures are in this way allocated to the private sector (producers and importers) with the risk that those costs will result anyway in an increase of product prices for consumers.

- There is no control mechanism foreseen to ensure cost-effectiveness of the system in the medium term.

Once a formal e-waste recycling sector is established, there will be no link between the level of the fees and the technical cost for e-waste recycling: for instance refrigerators have usually higher technical costs, and require higher capital investments for treatment technologies, while desktop PC nowadays in most cases have a positive net treatment costs, with limited capital investment needed for proper processing.

Nevertheless, both types of e-waste devices are charged with the same fee: 5 GHc.

Actually the technical cost (logistics plus treatment) of formal refrigerator recycling in Ghana is close to zero; this includes manual treatment and degassing (removal of CFC/HFCF from compressors and circuit) done as shown in Figure 10.



Figure 10: Formal refrigerator treatment in Ghana: mobile treatment plant for de-gassing of refrigerators (top); details on de-gassing operations (bottom left) on a refrigerator.

- There is no clear indication on the integration of informal sector (quite relevant in Ghana) in a formal e-waste recycling chain.
Recycling activities (treatment plants) as well as collection points need to be authorized by the Agency.
At the moment e-waste collection in Ghana mainly relies on a network of informal players, one-man companies in most of the cases, that are buying waste from consumers. They are subsequently delivering the appliances or fractions collected to other informal players, which are recycling it, often in a rudimentary way.
All those persons are actually surviving on e-waste collection and processing activities. Recent research⁷ (Abbas, 2014) showed that in the Agbogbloshie area, there is a weekly throughput (not only from e-waste recycling) of: 15 t of copper, 20 t of steel, 20 t of aluminium, which is significant in terms of jobs created and economic impact.
- Entrepreneurial activities in the e-waste sector are potentially suffering from un-fair competition: the entity responsible for issuing licenses (the Agency) is the same running a recycling plant, funded by recycling fees paid by producers.
Access to waste is also a critical competitive disadvantage for entrepreneurial activities given that collection infrastructures designated by municipalities are primarily handing over the waste collected to the plant operated by the Agency.
This might result, in the medium term, in a lacking cost-effectiveness of the system.

⁷ Data on market dynamics and material sold in Agbogbloshie available at <http://qamp.net/project/>

2.4.3 ACTIVITIES FINANCED UNDER E-WASTE LEGISLATION

Table 7 summarizes the activities financed under the e-waste legislation in Ghana.

	Stakeholder	Notes & Examples
Access to waste	N.A.	<ul style="list-style-type: none"> It is not specified if disposal should be free of charge to waste holders, nor if money from the Fund can be allocated for purchasing waste from consumers.
Containers	Producers	<ul style="list-style-type: none"> Responsible for providing the containers. Money raised from recycling fees is also allocated to maintenance of collection points.
Transport	Producers	<ul style="list-style-type: none"> Recycling fees cover transportation (done by treatment plant managed by the Agency).
Treatment	Producers	<ul style="list-style-type: none"> Recycling fees cover treatment costs (at least of the plant managed by the Agency).
Enforcement	Government	<ul style="list-style-type: none"> Enforcement is responsibility of Agency and Minister but no clear allocation of money from the “Fund” is foreseen in the bill.
Audit	N.A.	
Awareness Raising	Producers Government	<ul style="list-style-type: none"> Money is allocated from the “Fund” for awareness raising and research on e-waste.
Guarantees	N.A.	
Other costs	N.A.	

Table 7: Allocation of financial responsibilities (technical costs and framework costs) in Ghana proposed bill.

Figure 11 illustrates the material and financial flows in Ghana.

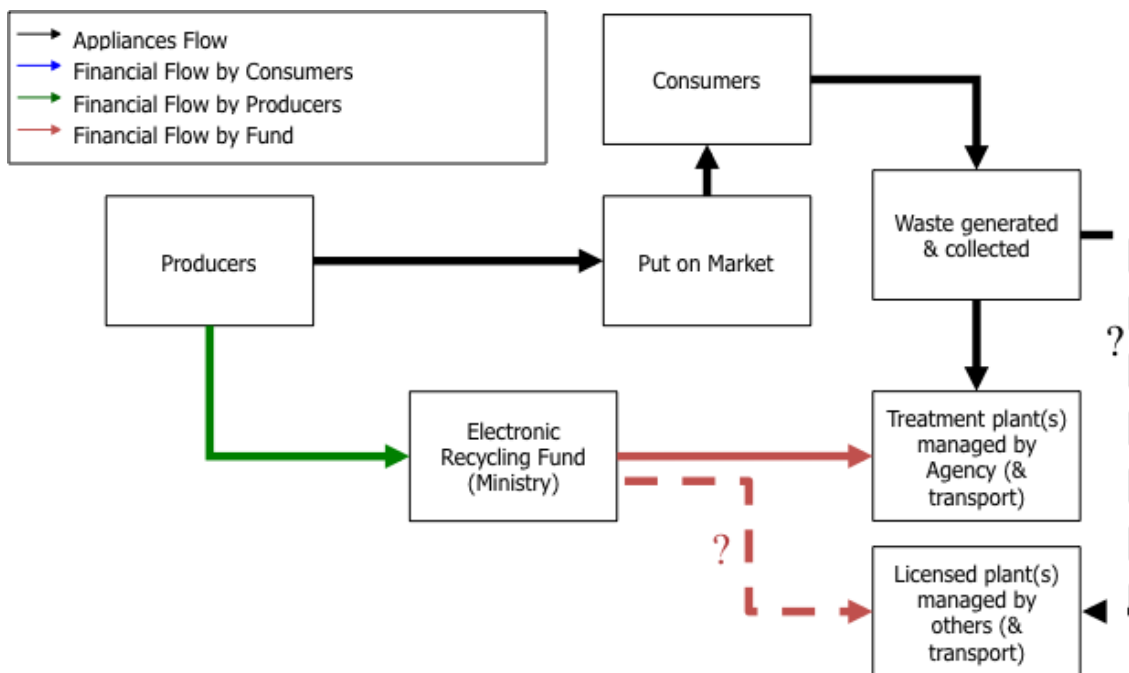

Figure 11: Financial and physical flow in Ghana.

2.5 SOUTH AFRICA

South Africa currently has no specific e-waste policy bill, despite formal e-waste recycling has been-going for years and even though a national e-waste association (eWASA⁸) has been established in 2008.

The legislative framework for current e-waste management in South Africa is based on the following:

- The Environmental Conservation Act, (Act 73 of 1989).
- The National Environmental Management Act (Act 107 of 1988)
- The NEMWA or National Environmental Management Waste Act (Act 59 of 2008)
- The Waste Amendment Act (Act 26 of 2014).

The last act in particular calls for the establishment of a pricing strategy for waste management and the implementation of industry waste management plans for specific waste streams.

Back in 2011, the National Waste Management strategy already called for the implementation of an EPR-based system for specific waste streams, including electronic waste. In addition to that, the establishment of a waste management bureau was foreseen with the main aim of controlling and advising on the implementation of the policies.

2.5.1 SCOPE & PROVISIONS OF LEGISLATION

⁸<http://www.ewasa.org/>

At the moment a working group comprising OEMs, e-waste practitioners, the retail sector, refurbishers, academia, process developers, importers and other stakeholders is working in conjunction with government, to finalize the Industry Waste Management Plan for e-waste.

The latest working document (V0.1.1, October 2014) will be used as basis for the analysis in the next chapter.

2.5.2 PRE-REQUISITES & PECULIARITIES OF THE FINANCING MODEL

The Industry plan tackles the societal challenges of e-waste management such as resource conservation, job creation, control over pollutants, using the EPR principle as financing mechanism and leveraging on the existing recycling infrastructures.

Despite the absence of specific provisions, which are legally binding, the plan allows to identify the fundamentals of the planned system:

- **Collection:** the role of informal collectors is acknowledged taking into account that they collect nearly 25 % of the currently processed e-waste in the country.
The Industry Plan foresees formal business-to-business collection from individual companies and other non-household users, while it calls for the establishment of municipal collection points and retailer take back for household e-waste.
Collection points and collectors are expected to register centrally and adopt minimum standards. E-waste collected will be available only for the licensed recyclers.
Consumer are granted free access to any collection point to drop off e-waste.
- **Treatment:** a network of e-waste recyclers already exists. They process from 5 to 1,000 tons of e-waste per month, in some cases with specific focus on particular appliances.
Main challenges are currently related to lacking downstream alternatives for hazardous fractions and to the implementation of environmental and safety standards (like ISO).
It is expected that only recyclers that will meet minimum standards will be authorized in the future to be part of the network.
Audit on standards are expected and results reported to Waste Management Bureau.
- **Financing:** The establishment of a Product Responsible Organization (PRO) is seen as cornerstone of the system.
Producers, defined as local manufacturers or importers of new/used products will be required to register with the PRO, declare annual amounts of products placed on the market, and pay the fees defined by the PRO to the South Africa Revenue Service, which is channelling them to the PRO through the Waste Management Bureau.
The PRO will calculate market share of Producers on the basis of products placed on the South African market. The PRO will also be responsible to gather data on e-waste collected individually by producers and account towards the fulfilment of their own share of responsibilities.

The PRO will be ultimately responsible for defining annual budgets and calculating financial obligations for its members, covering technical costs and the PRO running costs plus audit costs).

Charges will be paid by producers to the Ministry and from there be transferred subsequently to the PRO.

- **Information and reporting:** Producers are requested to report to the PRO the amounts of products placed on the market. Producers are also requested to report to the PRO the rates of e-waste collected individually.

2.5.3 ACTIVITIES FINANCED UNDER E-WASTE LEGISLATION

	Stakeholder	Notes & Examples
Access to waste	Producers	<ul style="list-style-type: none"> • Might be included, particularly to engage informal collectors. To be developed in the annual budget of the PRO.
Containers	Producers	<ul style="list-style-type: none"> • To be included in the annual budget of the PRO.
Transport	Producers	<ul style="list-style-type: none"> • To be included in the annual budget of the PRO.
Treatment	Producers	<ul style="list-style-type: none"> • To be included in the annual budget of the PRO.
Enforcement	Government	<ul style="list-style-type: none"> • Responsibility of municipalities and government.
Audit	Producers	<ul style="list-style-type: none"> • To be included in the annual budget of the PRO.
Awareness Raising	Government	<ul style="list-style-type: none"> • Responsibility of government, through the Waste Management Bureau.
Guarantees	N.A.	
Other costs	N.A.	

Table 8: Allocation of financial responsibilities (technical costs and framework costs) in South Africa.

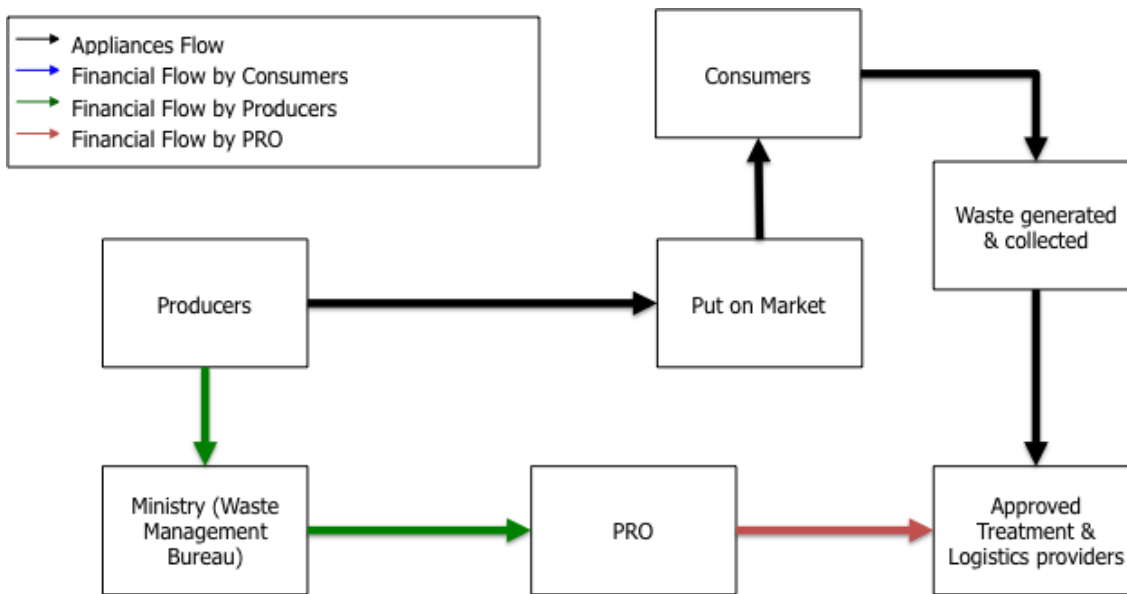

Figure 12: Financial and physical flow in South Africa.

2.6 KENYA

Kenya has developed an e-waste bill in late 2013, which has not yet been approved officially. It is nevertheless interesting to analyse the proposed model as described in the draft e-waste regulation.

It restricts the producers' financial responsibility to certain fractions only.

2.6.1 SCOPE & PROVISIONS OF LEGISLATION

The scope of e-waste bill is quite wide, closer to the one of the EU WEEE Directive, with the same 10 product categories of the original WEEE Directive.

In addition, batteries are also included in the scope of the legislation (portable, automotive and industrial ones).

The main provisions of the draft include:

- **Collection:** is responsibility of the waste generator – defined as “any person whose activity produces e-waste or the person who is in possession or control of that e-waste” – to properly dispose the waste through refurbishers (if the product is still working), collection centres or licensed recyclers.
Specific provisions on open burning, uncontrolled disposal or abandoning are included in the bill as well.
Refurbishers are responsible to transfer e-waste or components which are no longer useful to licensed recyclers.
Producers might also directly and individually channel to contracted recyclers.
Recyclers might set up collection infrastructures or stipulate agreements with logistics providers to ensure the waste is arriving at the facility.

The establishment of collection centres needs to be notified to authorities; notification includes the name of the recycling facility to which the collected e-waste is transported.

- **Treatment:** recycling facilities need to be licensed by authorities in accordance to general waste management regulations.
Recyclers, where possible, should give priority to refurbishment of appliances rather than recycling.
Specific provisions on quarterly reporting are also included and detailed in the following paragraphs.
- **Financing:** the extended producer responsibility principle is the cornerstone of the Kenyan regulation to fill the economic gap in proper recycling of certain fractions. In the draft bill the “problematic fractions” are defined as “those components or parts of e-waste where the collection and treatment costs outweigh the material recovery value”. This means that collection and treatment costs are born by recyclers and, where needed, producers financially support their operations.
Recyclers have an intrinsic interest in collecting and processing e-waste; for those products with positive net treatment cost, there is already the incentive in collection and treatment as they are directly contributing to the profits of the plant.
For products having a negative net treatment cost the financial support from Producers will fill the gap so that the proper treatment and the profitability of entrepreneurial activities are ensured.
- **Information and reporting:** the key element of the financing model is the establishment of a national register, responsible for the monitoring and fulfilment of obligations by different stakeholders.
Different provisions are established for different stakeholders:
 - Producers: defined in the broader sense – which involves also importers, are requested to register and declare amount of products placed on Kenyan market on annual basis, dived into product categories.
When applying for registration each producer should proof the contractual agreements with one of more licensed recyclers in order to fulfil his share of obligations.
Annually, producers should report and prove the payment for their “share” of financial obligations for the treatment of problematic fractions.
The National Register calculates the individual shares of responsibilities on the basis of total weight of products placed on the market in each product category.
 - Recyclers: have to quarterly report on the amount of e-waste collected and received, the products/components reused or refurbished, the amount recovered and recycled within the facility and the total amount of precious metals recovered.

The National Register is responsible to check and allocate to producers potential excess of total costs incurred by the licensed facilities to process the problematic fractions.

2.6.2 PRE-REQUISITES & PECULIARITIES OF THE FINANCING MODEL

The proposed model relies extensively on the entrepreneurial activities of recyclers and on the acknowledgment of the business dimension behind the e-waste collection and recycling.

This takes into account the net treatment cost principle, linking the role of Producers to the financial gap in proper treatment of certain products/components/fractions.

Some other elements can anyway be highlighted:

- In a competitive market, where more recyclers are active, it needs to be decided if the compensation for treatment of problematic fractions will be the same for all recyclers. Differences in the cost/revenue structure of each recycling plant are the basis for different prices that recyclers offer to customers (Compliance Schemes, Producers, individual waste holders).
- Compensation for treatment of problematic fraction needs to be reviewed as over time market conditions might change and different downstream players (disposing or recycling problematic fractions) in a competitive market might provide different prices.
- Role and interaction with recyclers and other stakeholders in establishment of compensation need to be clarified to avoid distortion of competition in case the compensation is recycler-specific, or un-necessary economic burdens ensuring cost-effectiveness of the entire system.
- From an overall cost-effectiveness perspective the absence of any intermediate body between the recyclers (the entity carrying out operations and affording the technical costs) and producers (the entity responsible to finance those costs) can increase the cost-effectiveness of the entire system and ensure a lean structure in the system. On the other hand, for small and medium sized producers it could be simpler and less burdensome having the chance to delegate to an external entity (like a compliance scheme) all the administrative aspects related to compliance (like reporting, scouting and signing contracts with licensed recyclers,...), as happen in Europe or other regions.

2.6.3 ACTIVITIES FINANCED UNDER E-WASTE LEGISLATION

	Stakeholder	Notes & Examples
Access to waste	Recyclers	<ul style="list-style-type: none"> Can be eventually complemented by Producers, for problematic fractions
Containers	Recyclers	<ul style="list-style-type: none"> Can be eventually complemented by Producers, for problematic fractions
Transport	Recyclers	<ul style="list-style-type: none"> Can be eventually complemented by Producers, for problematic fractions
Treatment	Recyclers	<ul style="list-style-type: none"> Can be eventually complemented by Producers, for problematic fractions
Enforcement	N.A.	<ul style="list-style-type: none"> It's expected to be borne, probably, by government
Audit	N.A.	<ul style="list-style-type: none"> It's expected to be borne, probably, by government
Awareness Raising	N.A.	<ul style="list-style-type: none"> It's expected to be borne, probably, by government
Guarantees	N.A.	<ul style="list-style-type: none"> It's expected to be borne, probably, by government
Other costs	N.A.	<ul style="list-style-type: none"> It's expected to be borne, probably, by government

Table 9: Allocation of financial responsibilities (technical costs and framework costs) in Kenya proposed bill.

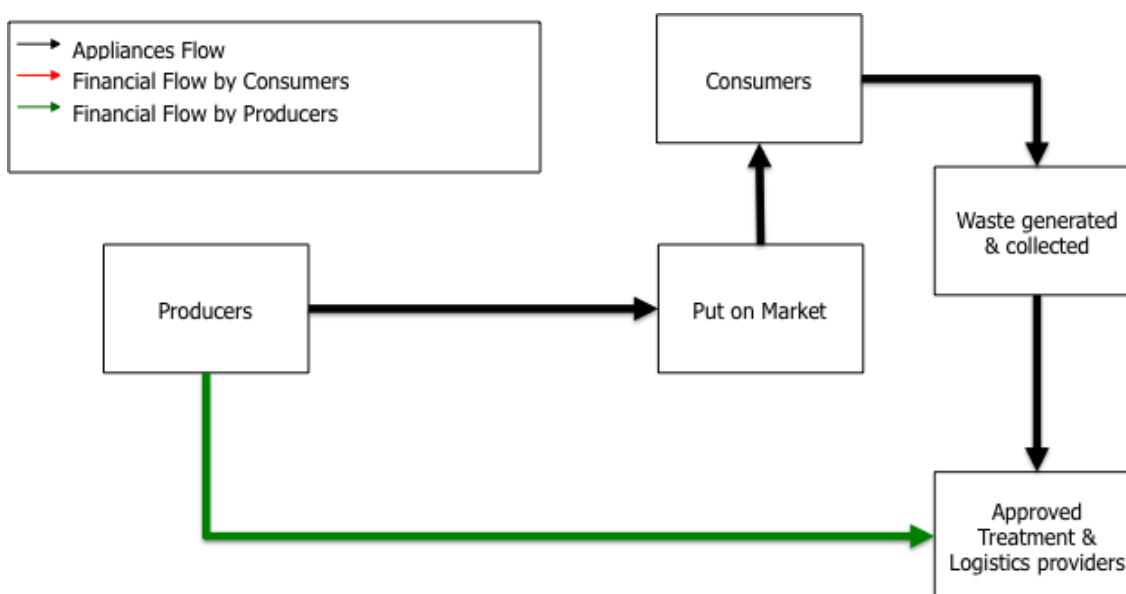

Figure 13: Financial and physical flows in Kenya.

3 POLICY OPTIONS FOR FINANCING E-WASTE MANAGEMENT IN ETHIOPIA

Chapter 2 presented six different models that are nowadays implemented or being discussed in different regions/countries.

Those models should now be confronted with the current background of Ethiopia and rated according to different indicators.

In this chapter provide an overview of boundary conditions for Ethiopia, an assessment of the costs for proper e-waste management and finally discuss different options that could be implemented in Ethiopia.

3.1 BOUNDARY CONDITIONS FOR THE FINANCING OF E-WASTE MANAGEMENT IN ETHIOPIA

3.1.1 PRODUCERS AND MARKET DYNAMICS

In 2013 a study (Oeko, 2013) revealed the still low penetration rate of electronic products in Ethiopia but at the same time, the current growth rate of the main indicators, particularly for products like mobile phones, PCs, and other large household appliances, particularly in populated areas and big cities:

- From 2008 to 2012 the coverage of the mobile phone network increased from 10 % to 80 % of the territory,
- Between 2006 and 2011 the annual growth rate of individuals using internet was nearly 29 %,

The majority of electronic equipment is imported and only a limited number of companies (5 according to Oeko, 2013) are producing/assembling locally mobile phones (and CRT-TV in the past) from imported parts and components.

Products are usually sold in small shops; like in many other developing countries, in Ethiopia there is also a vital reuse/refurbishing sector: this does not only provide affordable access to modern electronics for poorer people, but also represents the entry point for a considerable volume of products discarded over time.

Households as well as Quorales⁹ usually deliver old, and broken equipment to repair shops, which are using components and parts to repair broken products that are then sold.

In addition to products sold in shops, a considerable volume is smuggled (Oeko, 2014) into the country via Somalia (via Jigjiga) or Djibouti (via the Afar region).

⁹ Quorales are informal collectors of waste, acting individually and active across the entire country.

Smuggling mainly focuses on new equipment, but also used one can be contra-banded with an estimated share of less than 5 % of the total, focusing in particular on PCs.

The main drivers triggering smuggling are evasion of import taxes which range from 20 to 50 %, and the chance to sell products at lower price, roughly 30% of the average price in Addis Ababa.

Contraband is the main barrier to any EPR system, as the financial responsibility to be born by producers – either manufacturing or importing new or used products – is based on an accurate reporting of quantities.

In Europe, the free-riding (i.e. Producers not reporting to authorities quantities placed on national markets and escaping financing obligations) is observed as well, but is usually not linked to contraband and evasion of other taxes.

In the context of Ethiopia, an EPR implementation leading to additional fees and requirements to be fulfilled by producers would be a further incentive towards contraband, thus creating not only a lack of financial means for e-waste management, but also increase the total import tax evasion.

Notwithstanding that central government should take efforts to contrast smuggling for other reasons, it's clear that an EPR-based mechanism should ensure a level playing field across Industry to exploit its full benefits when it comes to an equal and fair share of responsibilities to be allocated to each producer.

For any model based on EPR registration of producers and reporting of quantities placed on the national market remains paramount for fair allocation of responsibilities.

3.1.2 WASTE AND E-WASTE MANAGEMENT CONTEXT

General waste management (household waste) is established in many urban areas in Ethiopia (Oeko, 2013). One of the pillars of solid waste management, particularly in the cities, is informal collection by Quorales, while no detailed information on their role in rural areas exists.

Quorales mainly focus on metal-dominated waste streams that are subsequently sold to scrap metal buyers.

In Addis and in other cities the city administrations set the fee for waste management. The fee is used to pay collectors when they deliver the waste.

There are different levels of fees and mechanisms used to charge households (or in some cases companies) for waste management:

- According to Oeko, 2014, the waste management fee in Addis is charged as a 2 % add-on to the water bill with a minimum of 10 BIRR/month.
Collectors are paid 400 BIRR/container. Considering one container is 8 cubic meters, and an average density of 134 kg/m³ for unsorted, un-packed municipal solid waste, this equals approximately 373 BIRR/ton: this can be assumed as baseline cost for primary collection of waste.
Companies are charged 73 BIRR per cubic meter (544 BIRR/ton). This could be assumed as baseline cost for disposal of waste from professional users.
- In Dire Dawa each household is charged 10 BIRR/month like in Hawassa, where the charge, however, applies to households where up to 5 persons are living.
Assuming (Aydamo et al, 2012) a daily generation of waste equal to 0,97 kg/family, the overall impact can be estimated to 345 BIRR/ton, which is quite consistent with charges in Addis.

Interestingly, citizens and companies have accepted that financial contribution is needed to finance proper collection and handling of solid waste generated by households or by their economic activities.

On the other hand products like old, broken, or unwanted electronics, are perceived to have a residual value so that in the great majority of cases they are not handed over for free.

A survey done by (Oeko, 2014) in fall 2014 found out that electronic products are sold either to repair shops (directly) or to Quorales as per Table 10. Quorales are in some cases selling to repair shops as well, which are using products/components as source of spare parts. At the very end, non-reusable products or fractions are sold to metal buyers or are disposed of.

Field research and interviews carried out by (Oeko, 2014) found also out that the majority of repair shops are selling fractions and material to scrap metals mainly with cash transactions without invoices.

Prices per unit discarded by households	Households sell to repair shops	Households sell to Quorales	Quorales sell to repair shops	Notes
CRT-TV (beyond repair but complete)	~ 550 BIRR	~ 450 BIRR	~700 BIRR	The price is relatively higher when repair shops sell repaired CRT-TVs to users
Refrigerator (beyond repair but complete)	~500 BIRR	~ 600 BIRR	~ 700 BIRR	For the purpose of repair or as source of spare parts
Desktop computer (beyond repair but complete)	~ 350 BIRR	~ 450 BIRR	~ 500 BIRR	For the purpose of repair or as source of spare parts
Computer Monitor (CRT, beyond repair but complete)	~ 150 BIRR	~ 200 BIRR	~ 250 BIRR	For spare parts
Mobile phone (beyond repair but complete)	~ 50-600 BIRR (depends on quality of the mobile phone)	~ 50-600 BIRR (depends on quality of the mobile phone)	~ 150-700 BIRR	

Table 10: Prices for EEE discarded by households (Oeko, 2014)

The price for access to waste and the role of the informal market represent relevant barriers to some of the EPR-based or formal e-waste systems models discussed in chapter 2.1 to 2.6 as:

- The access-to-waste” price can be very high and proper financing need to be identified. In the majority of e-waste management programs described in chapter 2 the access to waste is free of charge.
- The current level of access to waste price is mainly set by “repair” business. The prices paid are not linked to the intrinsic value of the materials contained in the products (metals, or other valuable fractions/components), but rather to the value of the products as source of spare parts for the refurbishment business. For those reasons, prices paid by repair shops cannot be offered when products are collected for recycling and material recovery purpose.

- The role of re-use and refurbishment of electronic products still play a crucial societal role in Ethiopia like in many other developing countries.
Collection and recycling should mainly target those flows that are not competing with the repair and refurbishment business.
From a waste management hierarchy reuse and refurbishment is anyway playing a crucial and in environmentally relevant role extending life of appliances and postponing the final disposal and material recovery of products.
- When products, parts, fractions of e-waste are concentrated in repair shops (or in companies), with no further chance of being used, the “informal” cash transactions from scrap buyers still represent an incentive to avoid any formal channel.
This driver is also relevant in case the price potentially offered by a recycler could be similar.
The evasion of taxes on profits is playing a crucial role in diverting flows to an informal system.
- From an environmental perspective the main focus should remain on the proper handling of hazardous fractions and critical materials where losses in non-efficient processes might lead to resource depletion.

Collection of e-waste should not be seen as an income source for waste holders.

Proper handling of e-waste generates costs that can only partially be compensated by revenues from certain materials streams.

e-waste management should not compete with established reuse and refurbishment businesses, but look at the residual fractions and products that are finally disposed.

3.1.3 OVERVIEW OF E-WASTE MANAGEMENT COSTS FOR ETHIOPIA

The cost for e-waste management can be estimated modelling the different activities along the entire recycling chain.

Annex6 provides detailed calculations and assumptions leading to the upper bound for the technical costs along the recycling chain for products representative of the different waste streams (except for lamps).

Framework costs (auditing, awareness raising, enforcement) are not taken into account at this stage as they might represent only a minor amount.

In addition to that, as chapter 2 described in detail, in majority of the cases are falling under the responsibility of central government, particularly when it comes to enforcement and monitoring.

Table 11 and Figure 14 summarize the main components of the recycling costs.

Overview technical costs along recycling chain (BIRR/t).	Dismantled & mixed e-waste	Desktop PC	CRT-Monitor	Washing Machine	Refrigerator
Access to Waste	-500	-8,660	-2,850	-6,600	-6,360
Cost for Containers	-5,667	-5,667	-5,667	-5,667	-5,667
Transportation	-8,000	-8,000	-8,000	-8,000	-8,000
Technical Treatment Costs	-6,809	-4,540	-2,853	-684	-1,705
Profit Facility	79	2,921	1,030	635	449
Revenues from fractions	8,945	19,350	3,655	7,460	7,310
Proper disposal hazardous fractions	-1,740	-204	-7,668	-3,600	-3,360
Gap from external sources for treatment	0	0	7,895	0	0
Financing available for other recycling chain steps	-317	-8,660	0	-2,541	-1,796
Total NET Technical Costs (No cross financing)	-14,167	-22,327	-16,517	-20,267	-20,027
Surplus in AKAKI (BIRR/t) available for cross-financing	0	3,024	0	0	0

Table 11: Overview technical costs along recycling chain (BIRR/t).

The table clearly highlights that for none of the waste streams, the revenues generated in the treatment phase compensate the total technical costs. The gap between the total cost for collection and treatment on the one hand and revenues from the sales of recycled materials varies per product type and over time, depending on the specific product composition and the varying prices for raw and recycled materials on the dynamic downstream markets.

This means that a financing mechanism for e-waste management must be identified and enforced to cover the cost gap.

This financing mechanism should take into account the market dynamics and enable the collection and proper treatment of all e-waste devices, which otherwise cause pollution and affect people's health and safety, and result in the loss of valuable resources.

Figure 14 gives an overview on the cost and revenue situation for various types of e-waste.

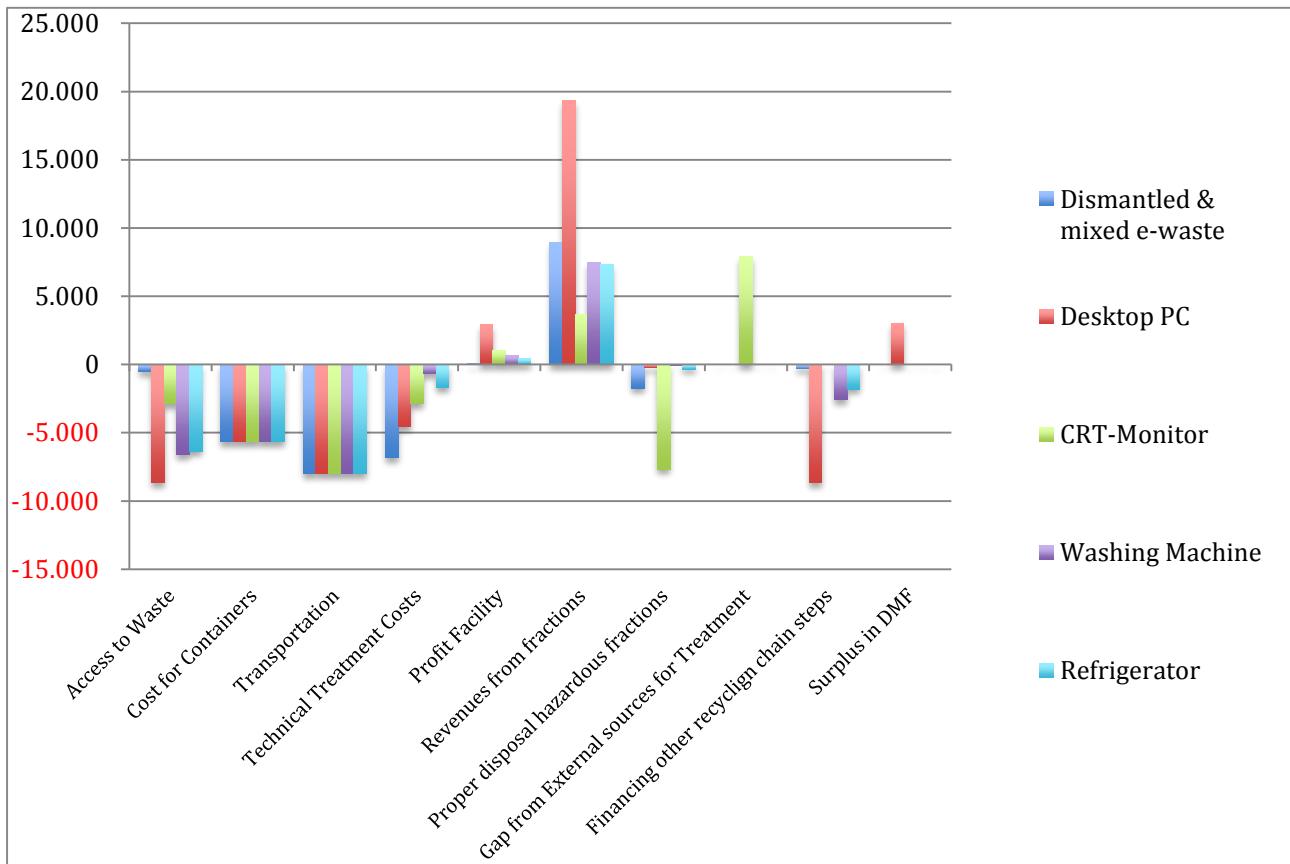

Figure 14: Overview technical costs along recycling chain (BIRR/t).

Costs for collection and transportation are calculated for a scenario where all the e-waste streams are collected together, thus causing the same cost for transportation which is simply obtained dividing the total cost for the weight transported.

In a long-term perspective, when volumes collected are increasing, dedicated collection points or containers/receptacles can be foreseen; in such cases, the impact of those two components of the technical costs can vary per waste stream in case more quantities are transported over the same routes.

Table 12 below compares the total technical costs for Ethiopia, converted in €/t, with the data available from EU:

- in 2005, during start-up phase of almost all the collection and treatment systems in the EU, and
- in 2011, when most of those systems had improved their operations and cost-effectiveness and progressive cost reduction was achieved.

Comparison total technical costs (€/t)	Dismantled & mixed e-waste	Desktop PC	CRT-Monitor	Washing Machine	Refrigerator
Total NET Technical Costs (BIRR/t) - No cross financing	-14,167	-22,327	-16,517	-20,267	-20,027
Total NET Technical Costs (€/t) - no cross financing	€ -590	€ -930	€ -688	€ -844	€ -834
Surplus available for the DMF (BIRR/t) for cross-financing	0	3,024	0	0	-0
Surplus for the DMF (€/t)	€ 0	€ 126	€ 0	€ 0	€ 0
Total NET Technical Costs EU (2005, €/t) MIN	€ -123	€ -123	€ -140	€ 0	€ -170
Total NET Technical Costs EU (2005, €/t) MAX	€ -574	€ -598	€ -598	€ -386	€ -740
Total NET Technical Costs EU (2011, €/t) MIN	€ 183	€ 17	€ -112	€ 125	€ -104
Total NET Technical Costs EU (2011, €/t) MAX	€ -440	€ -586	€ -681 ¹⁰	€ -296	€ -714

Table 12: Comparison total net technical costs (€/t) with EU. Access to waste price is derived from (Oeko, 2014)

Analysing more in detail the above table it can be highlighted:

- For dismantled and mixed e-waste the total cost is closer to the upper bound of EU, particularly using the 2005 data as reference (start-up). Certainly the cost for access to waste, which is in Ethiopia approximately 20 €/t for mixed e-waste and 360 €/t for PCs, keeps the overall technical costs high.

¹⁰ In 2011 costs the upper bound increased due to increase in LCD (higher costs) in the waste stream.

This is partially compensated by cheaper labour cost compared to the situation in the EU and consequently lower technical treatment costs.

- For desktop PCs the high cost for access to waste plays a crucial role in keeping the total technical cost much higher compared to the EU values.
- For CRT Monitor the values are in the range of EU values, closer to upper bound. As for the other waste streams the access to waste is playing the crucial role.
- For washing machines, the costs are much higher in Ethiopia compared to the EU. The main reason for that is the very high access to waste price. The high content of metals and relative lower electronic component increases on the other hand the chances that such waste stream could be more profitable and appealing for metal scrap players.
- Refrigerators show technical costs comparable to the EU upper bound. Experiences in Ghana show that a proper treatment allows a nearly positive net treatment cost. High access-to-waste-cost play again a crucial role in the overall breakdown of costs.

3.2 FINANCING MODELS FOR E-WASTE MANAGEMENT

The previous sections identified and estimated the technical costs for proper e-waste management under current Ethiopian conditions. Table 11 summarizes the technical costs and clearly highlights how a proper financing mechanism is needed to ensure environmentally sound management of e-waste.

Analysis of models presented in chapter 2 shows that no specific model, matching all the societal background conditions of Ethiopia, exists. The critical elements to be identified for the implementation of a successful financing model are:

- Selection of stakeholder or stakeholders responsible for financing, and
- Definition of the money flow.

The author is aware that the Ethiopian legislation targets an EPR scheme for the financing of e-waste management. The details of such a system are, however, not yet formulated in the current legislation ¹¹ leaving room for interpretation for how exactly this EPR scheme could be implemented in Ethiopia.

¹¹ Status April 2015

Additionally, this report wants to provide an overview on various possibilities to prepare the ground for informed political decision making rather than narrowing the perspective to EPR only.

Besides pure EPR models, hybrid and other financing schemes were therefore taken into account as well. Four different options are presented for financing e-waste management in Ethiopia:

- Waste holder financing, through taxes and in particular municipal solid waste (MSW) fee.
- Consumer financing, paying upon purchase of new products.
- Producer financing, as in pure EPR systems.
- A hybrid model where taxpayers are financing access to waste and Producers are financing the remaining steps.

Per each financing model, pros and cons will be highlighted in the following sections, and the baseline costs arising annually for the financing stakeholders will be estimated.

Averages costs estimated in Table 11 are used, combined with a baseline of e-waste generated across the country, to estimate the annual amount of BIRR needed to ensure a proper e-waste management in Ethiopia for the four waste streams included in the analysis.

In all the four models the total amount of money to finance e-waste management in one year remains the same; the stakeholder(s) responsible for financing will change.

Using estimations of waste generated from (UNU, 2015), Table 13 shows the annual total amount of waste generated and the expected total e-waste management cost based on the access to waste costs investigated by (Oeko, 2014).

Estimations of e-waste generated, on the basis of (UNU, 2015), has been done considering only those products that are used in main domestic applications and likely to represent the majority of e-waste arising volumes falling under the scope of the legislation.

	e-waste generated, UNU global e-waste monitor (kg/inhab, 2012)	Total e-waste (ton) generated in one year (assumed population of 87 Millions)	Cost for e-waste management (BIRR/t)	Total funding for e-waste management (BIRR/year), rounded	Note
C&F	0.02	1,506	20,027	30,151,000	
SCREENS	0.05	4,030	16,517	66,564,000	
LHHA	0.05	4,319	20,267	87,533,000	
SHA	0.15	12,931	19,303	249,615,000	Assumed the cost for Desktop PC using the surplus to finance other activities along the chain to minimize total economic impact.
Total	0.26	22,786		433,863,000	

Table 13: Estimation of total economic impacts for Ethiopia. Access to waste price is derived from (Oeko, 2014)

The estimated total amount of money needed to finance the expected amount of e-waste arising annually in Ethiopia is approximately corresponding to 433,863,000 BIRR. Such figure will be used as baseline in the analysis of the 4 different financing modes in the following sections.

3.2.1 CONSUMER FINANCING MODEL

There are two principal payment mechanisms how consumers can finance e-waste management:

- Through taxes, or
- When purchasing new appliances.

Financing Stakeholders and Payment Mechanism I

One principal option to finance e-waste management is to charge e-waste holders, similar to the fees generators of municipal solid waste (MSW) pay for the proper collection, treatment and disposal. Given the fact that the collection infrastructures for MSW and its payment mechanism are already in place and working (Oeko, 2014), one option to finance the e-waste management system is to leverage that for financing e-waste management.

The Lehulu¹² system in Addis Ababa collects the water, electricity and phone charges from private households in Addis Ababa.¹³ The Ethiopian Electric Power Corporation (EEPCO), EthioTelecom and the Addis Ababa Water and Sewage Authority – all governmental organizations – prepare the monthly bills for electricity, telephone and water/sewage. The bills are posted online; Lehulu can access them and collects the money from the households. Lehulu then transfers the collected money to the bank with the code of each agency (electricity, telephone & water).¹⁴ The 2% MSW fee is collected with the water bill.

The MSW management is financed by a 2 % add-on to the water bill with a minimum of 10 Birr per month, assuming that water consumption is related to the number of people living in the household and thus also to the amount of waste generated.

An analogue approach would be adding a certain percentage to the electricity bill. Consumption of electrical power is necessarily related to the use of electrical and electronic equipment, which would justify linking the e-waste management fee to the electricity bill.

The Lehulu agency could transfer the fee for e-waste management to the competent authority or organization responsible for e-waste management (Central Body in figure below) like it currently does with the MSW fees.

The figure below illustrates the financing model.

¹² Lehulu is Amharic and means “for all” according to Africa on the Rise, <http://www.africa-ontherise.com/tag/lehulu/>; accessed 13 April 2015

¹³ See Oeko 2014, page 12

¹⁴ E-Mail communication with Mr. Tadesse Amera, PAN Ethiopia, on 5 April 2015

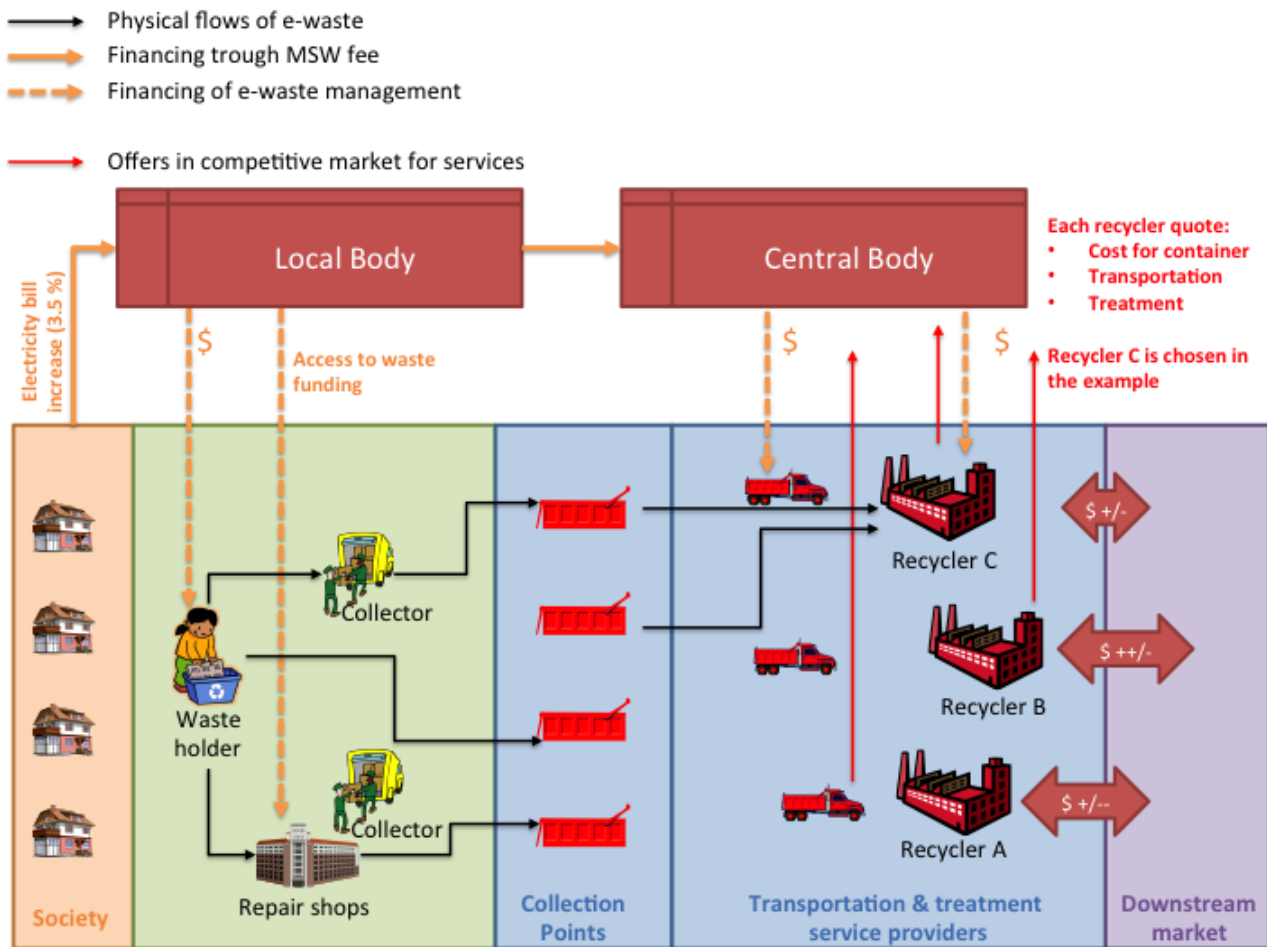

Figure 15: Financing model based on Electricity bill increase. Arrows shows financing of activities, not distribution of money to individual stakeholders.

The Lehulu system was started in Addis Ababa in 2013. The system shall be expanded over major cities over time.¹⁵ Where the Lehulu system is not available, the e-waste management fee could still be charged as a percentage of the electricity bill so that a homogeneous financing mechanism could be established all over Ethiopia.

Additional Requirements and Expected Impacts

To estimate the impact of charging e-waste management costs calculated in Table 13 through the electricity bill the average electricity consumption need to be estimated. In a study carried out by Department of Economics of Addis Ababa University (Gamtessa S., 2000) the average

¹⁵ Africa on the Rise, <http://www.africa-ontherise.com/tag/lehulu/>; accessed 13 April 2015

costs for use of Electricity form households is derived, equal to 60 BIRR/month for a household with up to 6 persons. The average is calculated through a survey conducted in households across the country.

	Population (estimated)	No. of Households	Monthly electricity bill (BIRR/household)
Reference data	87,000,000	17,400,000	60
Total Electricity fee for 1 year (BIRR)	12,528,000,000		
Total e-waste management fee (1 year)	433,863,000		
Average resulting increase (% and BIRR)	3.5 % - 2 BIRR/month		

Table 14: Estimation of Electricity bill fees increase to finance e-waste management (BIRR/year). Access to waste price is derived from (Oeko, 2014)

Table above shows how the average impact would result in an increase of approximately 3,5% on a monthly basis, equal to approximately 2 BIRR. This would mean having an average charge for monthly electricity bill equal to approximately 62 BIRR/household.

Alternatively, the e-waste management costs could be charged directly on the MSW fee. There is a slightly difference compared to the previous scenario as the MSW generation might not be correlated so strongly with the energy consumption. This means that all the citizens of Ethiopia would in this case pay, irrespective the quantity of e-waste they might generate.

The estimation of the potential amount of funding available in one year in the entire country is estimated assuming that the MSW charging mechanism applied in Dire Dawa and Hawassa is used across the entire country. This way it could be estimated the total amount of fees collected purely on the number of households (Dire Dawa) and persons living in households (Hawassa).

Using the upper limit of the Hawassa charging mechanisms (10 BIRR per household with up to 5 persons living), Table 15 shows the total amount of funding available for general municipal solid waste management across the entire country in one year.

	Population (estimated)	No. of Households	MSW Fee per household (BIRR/month)
Reference data	87,000,000	17,400,000	10
Total MSW fee for 1 year (BIRR)			2,088,000,000
Total e-waste management fee (1 year)			433,863,000
Average resulting increase (% and BIRR)			21 % - 2 BIRR/month

Table 15: Estimation of MSW fees increase to finance e-waste management (BIRR/year). Access to waste price is derived from (Oeko, 2014)

The table shows how in the case of financing the e-waste management via municipal solid waste, the increase of MSW fee should be around 21 %. This would mean having 2 BIRR/month charged in addition per household (corresponding to a total of 12 BIRR/month).

It should anyway be considered that, when e-waste volume increase the funding should also increase substantially as the average cost for e-waste management, as resulting from Table 13 is substantially higher compared to the average fees in BIRR/t paid for MSW management. This means that, in both cases, either charging through the electricity bill or the MSW, the percentage of increase might be higher if more e-waste is being generated.

One of the main reasons for this difference is the high cost of access to waste for e-waste management. In a medium-long term, if citizens/consumers will accept to hand over their e-waste without financial compensation, the increase can be also decreased.

The table below analyses pros and cons of the proposed approach.

PRO	CONS
Not creating further incentive for smuggling and contraband.	Is not in line with EPR principle established in the draft legislation.
Relying on existing structure for collection of fees.	Citizens might object the introduction of a new fee for e-waste as they already pay for MSW (of which e-waste is anyway part of). Might be difficult to enforce.
	No strong drivers for long-term cost-effectiveness of the system.
	Need to create a central entity to consolidate the funds and finance transportation and treatment.
	Each city administration might have to stipulate contracts for transportation and treatment of e-waste generated in its territory.
	Might be the risk that not all funds raised are being allocated to e-waste management activities. Transparency mechanism should be introduced to increase acceptance by taxpayers.

Table 16: Analysis pro/cons of financing model based on MSW fee increase.

Financing Stakeholders and Payment Mechanism II

The second option is based, like in the case of California, on the payment of a fee by consumers when purchasing a new (or used) appliance.

One fundamental step is the assessment of the fees for different appliances sold, which allow, on a yearly basis, to secure the total amount of funds needed for proper e-waste management. On the basis of (UNU, 2015), it has been calculated the corresponding cost of e-waste management in BIRR per each kg of product sold.

Assuming an average weight of products included in each specific stream, the price increase per single product sold can be roughly estimated, as shown in Table 17.

	Total funding for e-waste management (BIRR/year)	Estimated amount of EEE placed on Ethiopian market in 2012 (ton/year)	Incidence e-waste management cost per t of EEE placed on market (BIRR/t)	Average weight product in the stream (kg/product)	Potential price increase per each product sold (BIRR/product)
C&F	30,151,000	8,968	3,4	50	168
SCREENS	66,564,000	5,605	11,9	15	178
LHHA	87,533,000	10,839	8,1	55	444
SHA	249,615,000	11,627	21,5	4	86
Total	433,863,000	37,039			

Table 17: Estimation of product price increases to finance e-waste management. Access to waste price is derived from (Oeko, 2014)

From the money flow perspective, the same considerations apply like for the previous model.

Additional Requirements and Expected Impacts

The main aspect to be further investigated is related to the geographical asymmetry between collection of the fees, which is local, and the use of the funds raised. The financing of the e-waste management is partially local when financing access to waste and collection, and partially centralized to finance transportation, recycling and disposal.

In addition to that, a proper control mechanism should be established to ensure that all the money collected at shop level is transferred for e-waste management to the responsible entity and is not diverted or retained by the shops limiting the financial capability of the system.

The figure below illustrates how the model works. The arrows showing the financing are identifying the activities financed rather than the individual stakeholder. This in particular for access to waste, where the central body is not directly transferring the money to waste holders or repair shops, but more easily to collection points who are paying upon delivery of waste from the individual.

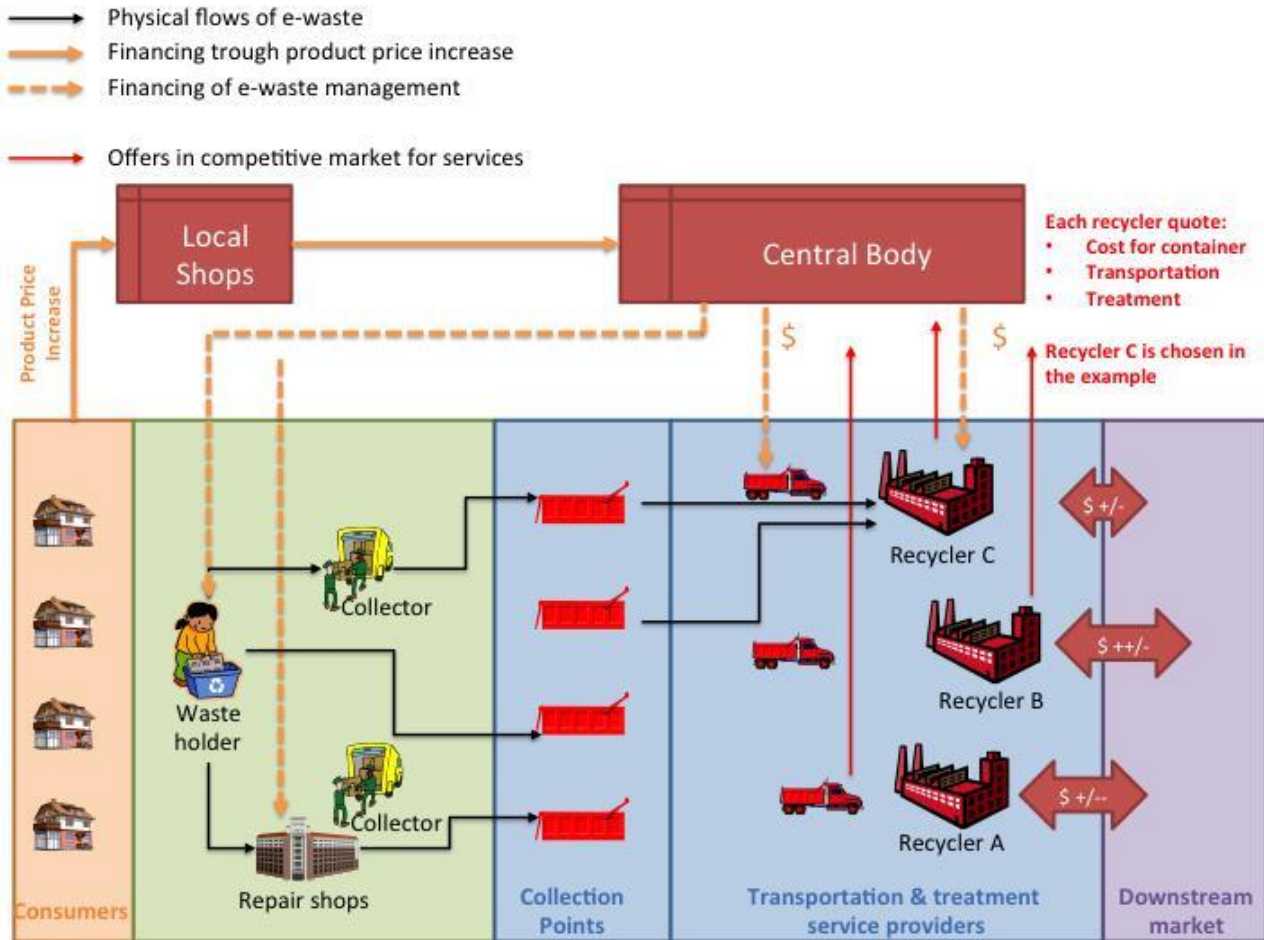

Figure 16: Financing model based on selling price increase. Arrows shows financing of activities, not distribution of money to individual stakeholders.

The next table analyses pro and cons of the proposed approach.

PRO	CONS
Only those persons purchasing electronic equipment (and consequently disposing them) are requested to finance the system, in line with the polluter pays principle as far as the consumers are considered as polluters, not the producers.	Is not in line with EPR principle established in the draft legislation.
	Citizens might experience an increase of product price.
	Might create further incentives for smuggling and contraband.
	Need to create a new structure/entity to collect funds from shops and control that all the money paid by consumers is being transferred to the responsible entity.
	No strong drivers for long term cost-effectiveness of the system unless the entity responsible for managing the fund is willing to stimulate the competition among logistics and treatment operations.
	Might be the risk that not all funds raised are being allocated to e-waste management activities. Transparency mechanism should be introduced, in order to increase acceptance by consumers.

Table 18: Analysis pro/cons of financing model based on selling price increase.

3.2.2 PURE EPR MODEL

Financing Stakeholders and Payment Mechanism

The third model is the pure EPR one, where EEE producers are financing the e-waste management. Producers in this sense are the manufacturers of the products, but may also include importers of used equipment and distributors of new and used equipment as long as the manufacturers do not have any representation in Ethiopia.

The legal definition of “producer” should make sure that each piece of EEE put on the Ethiopian market has a producer whom the Ethiopian Government can hold responsible for financing.

The economic impact of financing e-waste management is reported in Table 13. The usual approach is to share the economic burden on the basis of the market share of each producer on annual basis and per waste stream.

For example a company with 10 % market share in the cooling and freezing product sector in Ethiopia would have to finance 10 % of the total cost related to collection, transport, treatment and disposal of cooling and freezing equipment.

The fundamental pre-requisite of this approach is a proper reporting of products placed on the Ethiopian market by obliged parties (producers and importers). This will require establishing a National Register to which producers announce their sales per year and product category. This National Register would then calculate the individual producers' market share and control that each producer actually finances its share of e-waste management.

It must be assumed that producers refinance the e-waste management cost by increasing product prices, which may create a driver for smuggling.

Additional Requirements and Expected Impacts

From a money flow perspective the establishment of a Compliance Scheme might facilitate the collection and distribution of funding. In the majority of countries, particularly in EU, Producers established dedicated entities, which becomes responsible for meeting the take back obligations on behalf of individual producers. Each scheme decides how to charge their members (i.e. Producers) in order to finance the activities needed to ensure compliance with legal obligations.

Activities carried out by the scheme might include: identification of service providers for collection and treatment services, definition of contractual obligations and payment for take back services, audit for enforcement of quality standards and reporting of performances to national authorities, awareness raising campaigns and other activities eventually requested by members

A compliance scheme organized by the producers might increase the efforts to ensure cost-effectiveness in a medium term as the private sector is usually more keen to drive compliance costs down.

The cornerstone for such competition remains a well established and functioning EPR-based system is to have companies responsible for offering services (i.e. recyclers) to entities responsible for financing (i.e. Producers).

The below figure illustrates the model's basic functioning. The arrows showing the financing are identifying the activities financed rather than the individual stakeholder.

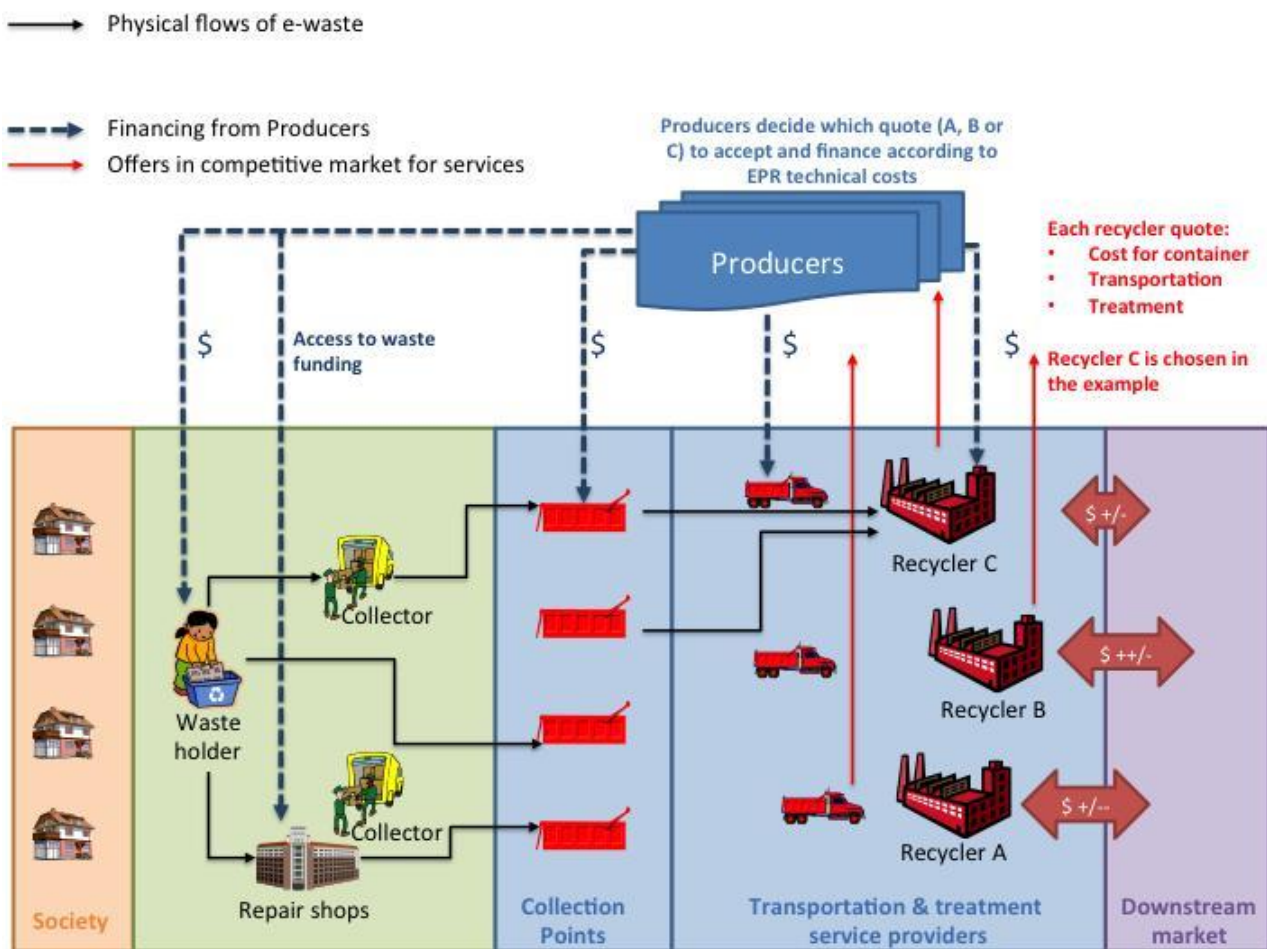

Figure 17: Financing model based on pure EPR system. Arrows shows financing of activities, not distribution of money to individual stakeholders.

The table below analyses pros and cons of the proposed approach.

PRO	CONS
Is in line with the EPR principle established in the draft legislation	<p>Increase the smuggling of electronic products into the country for producers trying to escape financial responsibilities.</p> <p>This is also creating a financial disparity and unfair competition/market distortion for legitimate industry complying with EPR principles versus free riders like contraband sellers and producers escaping the registration</p>
Strong efforts for cost-effectiveness of the entire system.	If producers are to finance also access to waste, it might lead to costs too high for industry to accept.
<p>No need to leverage on governmental entities for collection and distribution of funds.</p> <p>Funds paid by producers will be entirely allocated to e-waste management.</p> <p>Transparency mechanism should be anyway encouraged, reporting to the public on e-waste management costs and allocation of funds collected.</p>	

Table 19: Analysis pros/cons of financing model based on pure EPR.

3.2.3 SHARED RESPONSIBILITY MODEL

Financing Stakeholders and Payment Mechanism

The Shared Responsibility model combines the consumer financing mechanism with the EPR mechanism taking into account the local conditions in Ethiopia. The basic idea is to split the responsibility for financing e-waste management between the consumers of EEE and the producers trying to increase the overall cost-effectiveness of the system in the medium and long term.

The fundamental idea is to:

- secure the financing of access to waste (collection) via a percentage add-on to the electricity bill of the private households, and

- use the EPR mechanism for the subsequent steps including transportation from the collection points, treatment and disposal of the collected e-waste.

The private households consuming EEE, through a fee based on the electricity-bill is made responsible for the financing of access to waste. Access to waste cost is currently one of the roots of the high cost of the e-waste recycling chain in most of developing countries.

Making consumers responsible to finance this step could contribute to progressively change the attitude of consumers, which are expecting economic compensation when handing over e-waste, even when discarding the material for recycling

Most EU member states, even though having EPR systems in place for e-waste management, apply a shared responsibility model. The costs of e-waste collection are covered by taxes citizens pay for MSW in most member states.¹⁶

The producers pay for all costs arising from the takeover of the collected e-waste at the collection points including transportation from the collection point to the first and subsequent treatments, treatment cost, and cost for disposal of components and materials that cannot be recycled.

While in the EU, Japan or the USA, there is no cost for access to waste, in Ethiopia this cost dominates the total cost of the entire e-waste management system, as detailed in 6.1. The cost for access to waste is much higher for e-waste than for MSW, which private households and other waste owners give away for free in most cases.

Allocating these high costs to the producers may distort the market and create disadvantages for domestic and international producers as explained in chapter 3.2.2.

Further on, producers of EEE are not responsible for the high cost of access to waste. The underlying root causes are the socio-economic conditions, which producers of EEE can hardly influence. Once these socioeconomic conditions improve, the cost for access to e-waste will decrease as well.

The Lehulu system offers a good base for fair financing of access to waste by adding a certain percentage to the electricity bill. It would also be in line with the “The Polluter-Pays-Principle” as those households using more electricity can be assumed to use more EEE and thus also generate more e-waste, which needs to be paid for to obtain access to it.

Producers are not responsible for the cost arising for access to waste, but they can influence the average life-time of their EEE, the material contents as well as the design of EEE affecting the e-waste arising and the cost of treatment and disposal. It is therefore plausible to charge this part of the e-waste management cost to the producers according to the EPR principle.

¹⁶ See in Deubzer O., E-waste Management in Germany

Additional Requirements and Expected Impacts

According to the calculations done in Table 13 and detailed access to waste calculations reported in chapter 6.1 it is possible to identify the split of financing requirements between the citizens and the producers as shown in Table 20 below.

Total e-waste management costs (BIRR/year)	433,863,000
Average Access to waste costs (BIRR/t)	7,100
Estimated Access to waste cost (BIRR/year)	160,602,000
Other technical costs for e-waste management (BIRR/year)	273,261,000
Average resulting increase for citizens (% and BIRR)	1.3 % - 0.8 BIRR/month

Table 20: Estimation of funds available to finance access to waste through an increase of MSW fees (BIRR/t and BIRR/year). Access to waste price is derived from (Oeko, 2014)

In such model approximately 65 % of the financial burden is with the private sector, while a 35 % is allocated to citizens. But as explained earlier this share could potentially go down to zero in a long term if citizens accept to hand-over for free their e-waste for recycling to the established system.

Figure 18 shows the schematic functioning of the propose mechanism.

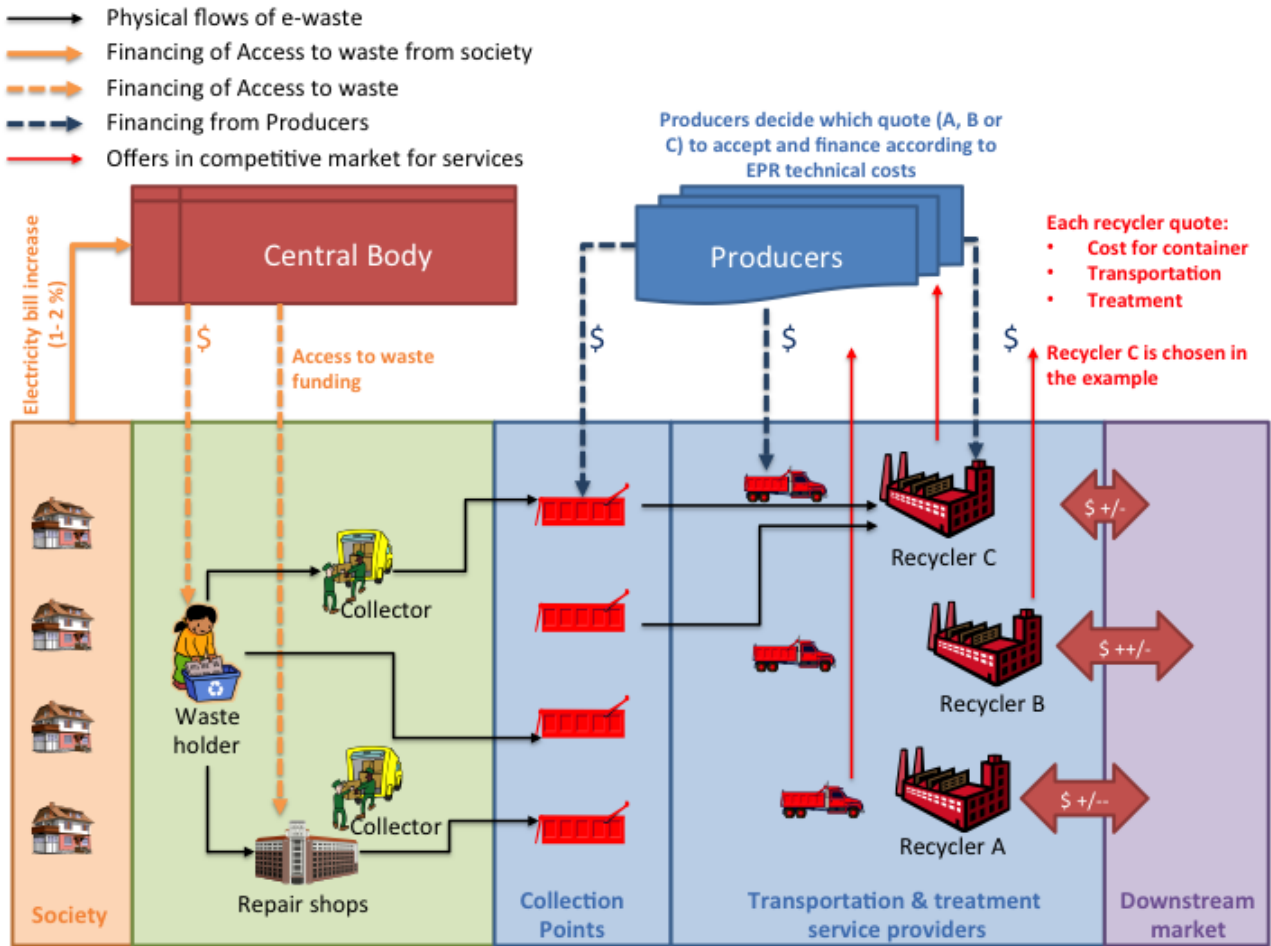

Figure 18: Schematic functioning of financing mechanism for Ethiopia. Arrows shows financing of activities, not distribution of money to individual stakeholder.

The table below analyses pros and cons of the proposed approach.

PRO	CONS
Is in line with the EPR principle established in the draft legislation	Citizens will have to pay additionally for waste management even though they already pay MSW management experience a slight increase of fees. Might be difficult to enforce.
Financial support from producers is limited to those cost that they can influence and hence can be held responsible for (net treatment cost). Reduced incentive for smuggling and black market trading of used and new EEE resulting in income-losses for the government.	
Strong efforts for cost-effectiveness of the entire system.	
Funding mechanism for access to waste builds on a system already established in Addis Ababa (Lehulu) and to be expanded over the country over time. Funds paid by producers will be entirely allocated to e-waste management. Transparency mechanism should be anyway encouraged.	

Table 21: Analysis pro/cons of financing model based on hybrid system

3.2.4 GENERAL ASPECTS AND CONDITIONS FOR SUCCESS

One key element of financing e-waste management, particularly through electricity bill increase (or MSW fee) to finance e-waste management and in particular access to waste could be to have this as “non-taxable revenue” for individuals of entities delivering the waste to the formal collection points.

The theoretical support for having such a tax exemption is to:

- Create a positive incentive for handing over e-waste collected into the formal system, particularly tackling the flows that are entering the black market through scrap metal buyers, particularly from repair shops;
- Avoid imposing taxes on financial flows that are generated through an increase of the MSW fee or electricity bill, which represents already a tax paid by citizens.

Such element could also be applied in a pure EPR model, despite, in such case, the funds for e-waste management are provided by the private sector as could trigger positive effects anyway: the establishment of a tax-exemption for transactions related to access to waste for individuals or companies (repair shops) could indeed create a direct and positive incentive to channel those products/fractions no longer suitable for re-use/refurbishment into a formal recycling system.

This could contrast one of the main drivers behind current transactions of cash between Quorales and other informal collectors and repair shops who sell material and fractions without invoices tracing those income to evade taxes.

This means that formal recyclers do not need to compete with informal recyclers on access to waste and, at the same time, informal collectors could still play a role in the formal system.

On the other hand, informal recyclers will still have to generate the funds to access to waste, and has a financial dis-advantage compared to formal ones.

In case this option is chosen the funds should be collected through the same routes of electricity bill or MSW fee. Key stumbling blocks remain to be further investigated:

- Once the responsible entity collected the fees it's important to define how access to waste can be financed and how the money could be distributed locally, to the persons (Quorales) or entities responsible for e-waste collection.
- Not in all municipalities or city administrations responsible of collecting the fee there might be a recycling plant for treating e-waste.
This means that a central body might be better positioned to consolidate the e-waste management funds once access to waste and collection has been financed accordingly and use the remaining funds to finance transportation and treatment.
Alternatively, each city administration should have own contracts with logistics providers and recyclers for the e-waste generated in its territory.

The second key element, common to all the financing models presented in previous paragraphs is to pursue the cost-effectiveness of the system in the medium term. This could be achieved creating a fair competition among companies offering services along the remaining part of the recycling chain (transportation and recycling in particular).

Once access to waste is secured (same conditions for different players), each entity can offer a quote to provide containers for collection, transportation to the facility and treatment services.

This means that every logistics provider and recycler on the market will compete, offering the best price possible, for:

- Rental of collection infrastructure,
- Transportation to the facility, and
- Treatment, on the basis of the net treatment cost principle, eventually developing an own cross-financing strategy on the basis of internal economies of scales, decision of profit level or competitiveness in developing more profitable downstream market opportunities.

It remains a paramount that companies offering e-waste management services should be licensed by a governmental entity, usually Ministry of Environment or Environmental Agency. The entity should be also responsible to ensure that:

- Minimum standards and requirements are met. This should be checked against checklists before issuing a waste permit to allow operations to start and with annual audits on the ground.
- Actual performances are reported. This means that mass balance of incoming material, fractions obtained and the destination of those, particularly for the hazardous components/fractions should be recorded, kept and made available for inspections from the authorities.

4 RECOMMENDATIONS FOR FINANCING E-WASTE MANAGEMENT IN ETHIOPIA

Not all the financing **models discussed** in the previous chapters are in line with the EPR principle, which is currently proposed in the draft Ethiopian legislation. Notwithstanding, they **all have strong elements** and common good practices, which the author recommends to take into account irrespective of the financing model selected:

- Payments of **entities to individuals delivering e-waste to formal e-waste collection points should be exempted from taxes**. This would keep the cost of access to waste lower and could create a positive incentive to channel material to the formal channel. At the same time such a mechanism could create a financial barrier for informal treatment operators and support formal ones.
- **Long-term cost-effectiveness** of the system could be **better pursued with an EPR-based system organized and implemented by the private sector**, as in other regions and countries private sector demonstrated to have more incentives and willingness to reduce the economic impacts of e-waste treatment.
- **Fair competition** between **logistics providers** and **recyclers** should be established. It's one of the **key drivers** for long-term **cost-effectiveness** of the entire system as long as **minimum quality standards** are defined and **enforced**.
- In any case **transparency on the real recycling costs** should be pursued also to **increase the awareness** of the consumers and the society at large **on the financial requirements** of a proper e-waste management. This can be achieved requesting all stakeholders to report on costs incurred for e-waste management and communicate to the public how the funds raised for e-waste management are allocated.
- The **e-waste collection** system should **not** aim at **competing with** the local **reuse and refurbishment sector**:
 - From a social perspective this sector contributes to access to electrical and electronic equipment for a growing number of Ethiopians.
 - From the environmental perspective this sector contributes to prevent e-waste by extending the life of appliances and postponing the final disposal and material recovery of products.
 - From an economic perspective, the reuse value of used EEE and of components thereof is much higher than their material value, which is the economic base for recycling. Thus only the material value can be the base for financing the access to

waste to keep this cost low and to maintain the input of UEEE into the repair and refurbishment sector.

- For EPR-based e-waste management systems, a proper **definition of the "producer"** is the cornerstone: the definition should not only refer to the manufacturer or the brand of the individual product, but should include **all the entities locally producing, assembling or importing new or used electrical and electronic equipment that is sold on the national market**. Such a definition vice versa also ensures that each piece of EEE has a producer whom the Government can hold liable for the cost arising once the EEE becomes e-waste.
- **Efforts** to tackle and **contrast smuggling**, should be **strengthened** particularly in EPR-based systems as escaping from e-waste financing responsibilities **creates market asymmetries** between the legitimate industry and other players.

Out of the models presented in chapter 3, the **shared responsibility approach** in the author's opinion **matches best the local conditions in Ethiopia**. It has the potential to be successfully implemented in the country for the following reasons:

- It is **based on EPR** and thus in line with the proposed legislation.
- It ensures a **fair allocation of financial responsibilities** among the two main stakeholders:
 - **Transportation and treatment** are based on **EPR** and in line with the most common approaches established worldwide and nowadays supported by Industry

The **private households consuming EEE**, through a fee based on the electricity-bill is made responsible for the **financing of access to waste**. Access to waste cost is currently one of the **roots of the high cost** of the e-waste recycling chain in most of developing countries.

Making consumers responsible to finance this step could contribute to progressively **change the attitude of consumers**, which are **expecting economic compensation** when handing over e-waste, even when discarding the material for recycling. This would not affect the current reuse and refurbishment businesses and practices as the model does not aim at diverting material from the reuse/refurbishment to material recovery.

- Allocating the cost for access to waste to EEE consumers contributes to prevent overburdening the formal private sector, which might result in strongly increasing product prices. This would create incentives for black markets and smuggling and good willingness to implement the system across the entire country.

- The shared responsibility model could **leverage the existing local organizations and infrastructures** like the Lehulu system to collect the resources for financing the access to waste.

5 REFERENCES

Baldé, C.P., Wang, F., Wong, J, Kuehr, R., Huisman, J. (2015), The global e-waste monitor – 2014, United Nations University, IAS – SCYCLE, Bonn, Germany.

Seyring N., Kling M., Weißenbacher J., Hestin M., Lecerf L., Magalini F., Sinha Khetriwal D., Kuehr R., (2015) Study on WEEE recovery targets, preparation for re-use targets and on the method for the calculation of the recovery targets, Study for DG ENV

OECD, (2006), Working Group on Waste Prevention and Recycling: EPR Policies and Product Design: Economic Theory and Selected Case Studies

Lindhqvist, Thomas (1992). Extended Producer Responsibility. In T. Lindhqvist, Extended Producer Responsibility as a Strategy to Promote Cleaner Products. (1-5). Lund: Department of Industrial Environmental Economics, Lund University.

BIO by Deloitte (2014), Development of Guidance on Extended Producer Responsibility, Study for DG ENV

Manhart A., Amara T., Belay M., (2013), E-waste country study Ethiopia, Oeko Institute and PAN Ethiopia

Schleicher T., Manhart A., Amara T., Belay A., Genet Z., (2014), An Efficient and effective e-waste collection system for Ethiopia, Oeko Institute

Deubzer O., Eshetu Gizaw B., Herbeck E., Fikreyesus D., (2014), National and international downstream markets for DMF e-waste dismantling fractions, UNIDO.

Favot, M., Marini, A., (2013), A statistical analysis of prices of electrical and electronic equipment after the introduction of the WEEE Directive. Journal of Industrial Ecology. 17(6): 827-834.

Gamtessa S., Household's Consumption Pattern and Demand for Energy in Urban Ethiopia, Department of Economics, Addis Ababa University, 2000.

Deubzer O., E-waste Management in Germany, report from 20 July 2011 commissioned by the "Deutsche Gesellschaft für Internationale Zusammenarbeit" (GIZ) GmbH, published by United Nations University; available from <http://isp.unu.edu/publications/scycle/files/ewaste-management-in-germany.pdf>, also available from http://ec.europa.eu/environment/waste/wEEE/links_en.htm

6 ANNEX 1 – ECONOMIC MODELING OF E-WASTE MANAGEMENT COSTS

In this Annex an estimation of technical costs for e-waste management in Ethiopia will be carried out, considering the existing structure of the DMF.

Further recycling facilities could be established in the future but it is assumed that the cost structure could be the same like at the DMF.

The modelling will allow identifying the cost ranges for activities to be financed and identify how those costs could be fairly allocated to different stakeholders to ensure the cost-effectiveness of the entire system on the one hand, and on the other hand to prevent undue financial hardships for any of the stakeholders.

Per each cost the main hypothesis will be discussed in the following sections. Information and data available from other TF work are included, where possible.

The technical costs, as described in 1.4.1 are modelled and estimated for Ethiopia.

6.1 ACCESS TO WASTE

Table 22 provides costs for access to waste for selected products, which are representative of different waste streams as has been investigated by (Oeko, 2014). In the table reference values for other developing countries are provided.

Values for Ecuador, Ghana and South Africa have been retrieved via interviews with plant managers in those countries. In all the cases conversion in €/t is provided.

Product type	Waste Stream	Ethiopia		Ghana		Ecuador		South Africa	
		BIRR/t	€/t	\$/kg	€/t	\$/kg	€/t	\$/kg	€/t
Dismantled & mixed e-waste	SHA	-500	€ -21			\$ -0.10	€ -85	\$ -0.07	€ -59
Desktop PC	SHA	-8,660	€ -361	\$ -0.20	€ -170	\$ -0.10	€ -85	\$ -0.07	€ -59
CRT-Television (damaged tube)	SCREENS	-2,030	€ -85			0\$ to \$ -0.10	€ -85	\$ -0.07	€ -59
CRT-Television	SCREENS	-2,540	€ -106			0\$ to \$ -0.10	€ -85	\$ -0.07	€ -59
CRT-Monitor (damaged tube)	SCREENS	-2,280	€ -95			0\$ to \$ -0.10	€ -85	\$ -0.07	€ -59
CRT-Monitor	SCREENS	-2,850	€ -119	\$ -0.20	€ -170	0\$ to \$ -0.10	€ -85	\$ -0.07	€ -59
Washing Machine	LHA	-6,600	€ -275			\$ -0.10	€ -85	\$ -0.07	€ -59
CFL-lamp	LAMPS	-2,000	€ -83			\$ -0.10	€ -85	\$ -0.07	€ -59
Refrigerator (damaged cooling circuit)	C&F	-5,090	€ -212			\$ -0.10	€ -85	\$ -0.07	€ -59
Refrigerator	C&F	-6,360	€ -265			\$ -0.10	€ -85	\$ -0.07	€ -59
Air Conditioner (damaged cooling circuit)	C&F	-11,000	€ -458			\$ -0.10	€ -85	\$ -0.07	€ -59
Air Conditioner	C&F	-13,740	€ -573			\$ -0.10	€ -85	\$ -0.07	€ -59

Table 22: Access to waste for different products in different countries.

The analysis of the table above highlights some key aspects:

- On average, for almost all the products (except for dismantled and mixed e-waste) the access to waste for Ethiopia is higher, sometimes massively. The case of Desktop PC (one

of the most common products that can be found in waste streams) shows particularly high differences also compared to Ghana.

- Should also be noted how, particularly for the case of Ecuador and South Africa recyclers prefer to use a “flat” fee for all the products; this appears to be simpler but also highlight some internal cross-financing of different waste streams.

Having different prices for different products does not allow calculating an average cost for access to waste, as this is highly dependent on the specific mix of waste arising.

According to (Oeko, 2014), the total budget for the pilot in the EwaMP project, has been set to nearly 72,000 BIRR for an estimated 8.3 t to be collected.

This results in approximately 8,660 BIRR/t (approx. 360 €/t).

The amounts and mix of e-waste arising in Ethiopia as calculated in (UNU, 2015) corresponds to approximately 6,600 BIRR/t (7,100 BIRR/ton excluding Lamps from the calculations), which remains considerably higher than the averages for Ecuador and South Africa.

Table 23 shows the costs for different types of e-waste.

Waste stream	Waste Generated (kg/inha)	%	Reference access to waste (BIRR/t)	Weighted access to waste (BIRR/t)	Note
C&F	0.02	5.96 %	-6,360		Refrigerator used in the scenario
SCREENS	0.05	15.96 %	-2,850		CRT Monitor used in the scenario
LAMPS	0.03	9.77 %	-2,000		
LHHA	0.05	17.10 %	-6,600		
SHA	0.15	51.21 %	-8,660		Desktop PC used in the scenario
Total	0.29	100 %		-6,593	

Table 23: breakdown of e-waste generated in Ethiopia and average access to waste cost (BIRR/t).

Table 24 below compares, for few products, the economic value of products disposed of and entering the re-use and refurbishment channel with the access-to-waste values.

Prices in BIRR/ton	Households sell to repair shops	Households sell to Quorales	Quorales sell to repair shops	Access to Waste
CRT-TV (beyond repair but complete)	22,000	18,000	28,000	2,540
Refrigerator (beyond repair but complete)	10,000	12,000	14,000	6,360
Desktop computer (beyond repair but complete)	38,889	50,000	55,556	8,660
Computer Monitor (CRT, beyond repair but complete)	10,000	13,333	16,667	2,850

Table 24: Comparison access to waste and refurbishment market prices.

The cost for accessing waste can only be based on prices for materials and components which can no longer be used for repair and refurbishment, which is essentially what repair shops sell to formal or informal collectors.

This will be further detailed in section 6.4: the intrinsic economic value resulting from proper treatment of products, with the aim of recovering the material, cannot outweigh the cost of purchasing equipment with reuse value from households or Quorales.

6.2 COST FOR COLLECTION

Cost for containers is also derived from (Oeko, 2014). Estimation of 7,500 BIRR/month for rental is considered the upper limit, as used containers could be purchased and the monthly depreciation, over 2 years of residual lifetime can be lower. Used 20ft containers can be purchased for 75,000 BIRR¹⁷.

The FTE (full time equivalent) for a person responsible for monitoring the container and potentially keeping track of quantities delivered by formal collectors, citizens or Quorales is equal to 20 %.

Despite the maximum load for a 20ft container could be higher, an average load of 3 is estimated. This is considered as average for un-packed mixed e-waste. In EU well loaded container (20 cubic meters) usually have a weight ranging from 2 t (C&F) up to 5 t (LHHA or

¹⁷ Internet search carried out on 27/01/2015.

mixed WEEE). Considering the loading of the 20ft container is from one side (Figure 19) it is reasonable to estimate the full capacity cannot be achieved anyway.



Figure 19: Collection of e-waste using 20ft containers (from Oeko, 2014).

To calculate the impact of cost for containers in BIRR/t the monthly disposal rate is estimated to be around 1.5 tons of e-waste. Having a higher disposal rate will decrease the impact of the cost for containers, so the current assumption could easily represent the upper bound.

Considering the e-waste generation estimations of (UNU, 2015) a monthly disposal rate of 1.5 tons equal to approximately the e-waste generated by a population of 62,000 persons in one month.

Such estimations should be further validated during the pilot collection planned in the EwaMP project.

Table 25 summarizes the hypothesis and provides the cost estimation for containers.

Cost for containers & collection infrastructures (BIRR/t)	
Rent 20ft Container (BIRR/month)	-7,500
FTE for collection centre	20 %
Monthly salary operators collection centre (BIRR/month)	-5,000
FTE per collection point (20% time, BIRR/month)	-1,000
Average t/load	3
Disposal rate (t/month)	1,5
Total Cost for Containers (BIRR/t)	-5,667
Total Cost for Containers (€/t)	€ -236

Table 25: Cost for containers & collection infrastructures (BIRR/t).

6.3 TRANSPORTATION

Transportation costs could play a major role considering that actually only one facility is existing and that travel distances and travel time between different cities in Ethiopia is substantial. Quotes provided in (Oeko, 2014) for transportation from different cities of Ethiopia to AKAKI (Hawassa and Dire Dawa) have been used.

The resulting average cost per mile (80 BIRR/km, equal to approximately 3,2 €/km) is not substantially higher compared to EU standards for waste transport over long distances.

Considering an average load of 3 ton/travel and an average distance of 300 km from the recycling plant, the resulting transport cost, as displayed in Table 26, is equal to 8,000 BIRR/t. Of course in case of higher loads the impact could be lower so, again, the value can be seen as upper bound.

Cost for transport (BIRR/t)	
Transportation cost (BIRR/km)	-80
Average t/load	3
Average distance to AKAKI (km)	300
Average transportation cost (BIRR/t)	-8,000
Average transportation cost (€/t)	€ -333

Table 26: Cost for transport (BIRR/t).

6.4 TREATMENT

The treatment phase in the entire e-waste recycling chain is the fundamental one; it's where the economic intrinsic value of the product can be recovered, and the revenues may compensate at least part of the costs incurred in the previous phases according to the net treatment costs principle explained in chapter 0. The analysis below considers three logical steps:

1. The technical treatment costs are first considered. Technical treatment costs represent the total amount of expenses needed to run the recycling plant (DMF). Those costs may depend on the quantities processed (f.i. energy consumption); in other cases they are not related to the quantities processed (f.i. salaries of staff).. Despite in the case of the DMF the initial investment for the facility and the machines was already covered with external financial support, an annual depreciation is estimated in the calculations for the building (over 15 years) and for the machines (over 5 years). This reflects the annual share of future investment to upgrade or replace the processing lines and for the maintenance the building. On the basis of the offers for the equipment currently purchased for the DMF facility is estimated a total investment of 2.5 MBIRR for machines. Is also estimated an investment of 6 MBIRR for the facility.
2. The average composition of products and downstream market values allow estimating the revenues for the material recovered and costs for those that need a proper disposal.
3. The comparison of technical treatment costs and total intrinsic value per different products or waste stream allow estimating the net treatment costs. The analysis of gap/surplus in the economics of waste streams treatment allows to further elaborating on the strategy for the recycling plant to maximise revenues in the long term.

6.4.1 TECHNICAL TREATMENT COSTS

Five products, from those listed in Table 22 have been used as representative of four waste streams. Lamps are excluded as:

- Their treatment is mainly consisting in fully automated treatment in dedicated machines which is currently not available in AKAKI;
- Considering the limited volume usually collected, the installation of treatment capacity appears not justified at the moment as small quantities of lamps potentially collected could be exported for treatment.

Each product has been analysed as standing alone. This means that for each product it has been assumed that the facility process 100% of that specific waste stream.

The majority of costs are volume specific (f.i. energy, dismantling costs). Only maintenance costs as well as salary for management and administrative staffs are common to all waste streams in a real scenario, where a mix of different products is collected and processed during the month.

The same applies to the annual depreciation for the facility and the machines, which is, in reality, common to all waste stream processed.

This means that the incidence of such costs (in BIRR/t) is varying and is charged on the basis of the real product mix or could be calculated on the basis of the total throughput of the facility.

As a consequence, in the real scenario, the impact of maintenance costs, staff salary and depreciation will be lower per each waste stream.

This means that the costs indicated per waste stream can be considered as upper bound.

Dismantling efficiency has been estimated for each product considering high dismantling time (approximately 4 devices dismantled per hour, 2 in the case of refrigerators), compared to experienced workers in facilities active in other countries.

The higher the dismantling efficiency and throughput of the employees is, the lower is the impact of technical cost.

Table 27 summarizes the results for different waste streams. For proper treatment of refrigerators and air conditioners, particularly those containing CFC and HCFC technical costs could be higher, especially to ensure the de-gassing of circuits (see Figure 10) an proper disposal of foam containing hazardous blowing agents. Purchase of a de-gassing unit for refrigeration circuit should be included.

Treatment costs (BIRR/t)	Dismantled & mixed e-waste	Desktop PC	CRT-Monitor	Washing Machine	Refrigerator
Cost employees (BIRR/month)	-5,000	-5,000	-5,000	-5,000	-5,000
Working days/month	21	21	21	21	21
Dismantling efficiency of each employee (t/day)	0.2	0.3	0.48	2	0.8
Products processed per day (product/day*employee)	57	33	32	30	16
Labour cost (BIRR/t)	-1,190	-794	-496	-119	-298
Salary General Manager + 1 Adm Staff (BIRR/month)	-25,000	-25,000	-25,000	-25,000	-25,000
Salary Plant Supervisor (BIRR/month)	-7,500	-7,500	-7,500	-7,500	-7,500
Total Mgt+AdM Staff (BIRR/t)	-1,548	-1,032	-645	-155	-387
Energy cost (BIRR/kWh)	-0.27	-0.27	-0.27	-0.27	-0.27
Shredder throughput capacity (t/h) ¹⁸	2.00	2.00	2.00	2.00	2.00
Shredder Energy consumption (kW)	25.00	25.00	25.00	25.00	25.00
CRT cutter throughput capacity (units/h)	-	-	20.00	-	-
CRT cutter Energy consumption (kW)	-	-	15.00	-	-
Total Energy Consumption (BIRR/t)	-3.38	-3.38	-16.88	-3.38	-3.38
Maintenance cost ¹⁹ (BIRR/year)	-125,000	-125,000	-125,000	-125,000	-125,000

Treatment costs (BIRR/t)	Dismantled & mixed e-waste	Desktop PC	CRT-Monitor	Washing Machine	Refrigerator
Maintenance cost (BIRR/t)	-496.03	-330.69	-206.68	-49.60	-124.01
Number of persons on dismantling line	5	5	5	5	5
Annual share depreciation machines (5years)	-500,000	-500,000	-500,000	-500,000	-500,000
Depreciation impact (BIRR/t)	-1.984	-1.323	-827	-198	-496
Annual share depreciation facility (15years)	-400,000	-400,000	-400,000	-400,000	-400,000
Depreciation impact (BIRR/t)	-1,587	-1,058	-661	-159	-397
Total throughput facility (t/month)	21	31.5	50.4	210	84
Total Treatment cost (BIRR/t)	-6,809	-4,540	-2,853	-684	-1,705
Total Treatment cost (€/t)	€ -284	€ -189	€ -119	€ -28	€ -71

Table 27: Treatment costs (BIRR/t).

6.4.2 AVERAGE COMPOSITION AND DOWNSTREAM MARKETS

Average composition for products has been retrieved from (Oeko, 2014) to ensure consistency in the project documents and also allow comparison with the access to waste calculations carried out in TF-Collection work.

Five main value-carrier elements have been included, as per the downstream report (UNU, 2014): steel, aluminium, copper, PWB and Plastics. The average share of plastics has been derived from (UNU, 2014).

¹⁸ Throughput capacity and energy consumption of shredder and CRT cutter are taken from technical sheets of equipment purchased for AKAKI facility.

¹⁹ Calculated on the basis of technical data sheets of equipment purchased.

Despite, in reality, some other components or fractions resulting from manual dismantling of individual products/waste streams could have a positive value (f.i. HDD, Processors,...), to estimate the lower bound (worst case scenario), the remaining weight of each product/waste stream has been allocated to fractions having negative value.

In the case of CRT this is mainly consisting of the lead-containing glass. Table 28 display the overall average compositions per each product/waste stream.

Average Composition	Dismantled & mixed e-waste	Desktop PC	CRT-Monitor	Washing Machine	Refrigerator
Steel	50 %	69 %	6 %	53 %	50 %
Aluminium	2 %	4 %	0 %	3 %	3 %
Copper	1 %	6 %	5 %	4 %	4 %
PWB	3 %	9 %	0 %	0 %	0 %
Plastics	30 %	10 %	25 %	10 %	15 %
Other fractions with positive value	0 %	0 %	0 %	0 %	0 %
Other fractions with negative value	15 %	2 %	64 %	30 %	28 %
Total	100 %	100 %	100 %	100 %	100 %

Table 28: Average composition selected products (Oeko, 2013 plus external sources).

Downstream market values for the 5 value-carrier elements have been derived from (UNU, 2015).

For disposal of fractions with negative value a cost of 12,000 BIRR/t has been estimated, including the transport from AKAKI to Djibouti, assuming a proper disposal/treatment overseas.

This assuming an average disposal cost of approximately 150 €/t, but excluding potential notification costs (f.i. costs related to Basel Convention compliance) which are still to be investigated and clarified with Ethiopian ministries and agencies involved.

Table 29 summarizes the values considered in the calculations.

Market value (BIRR/t)	
Steel	9,000
Aluminium	15,000
Copper	50,000
PWB	100,000
Plastics	2,400
Disposal Fractions Negative Value	-12,000

Table 29: Downstream market opportunities (BIRR/t).

Data and assumptions of Table 28 and Table 29 allow calculating the intrinsic economic value per each product/waste stream as shown in Table 30.

Economic content (BIRR/t)	intrinsic product	Dismantled & mixed e-waste	Desktop PC	CRT-Monitor	Washing Machine	Refrigerator
Steel		4,500	6,210	540	4,770	4,500
Aluminium		225	600	15	450	450
Copper		500	3,000	2,500	2,000	2,000
PWB		3,000	9,300	0	0	0
Plastics		720	240	600	240	360
Other fractions with negative value		-1,740	-204	-7,668	-3,600	-3,360
Total intrinsic value (BIRR) per t of product		7,205	19,146	-4,013	3,860	3,950
Total intrinsic positive value (BIRR) per t of product		8,945	19,350	3,655	7,460	7,310
Total intrinsic negative value (BIRR) per t of product		-1,740	-204	-7,668	-3,600	-3,360
Total intrinsic value (€) per t of product		300	798	-167	161	165
Share of access to waste on intrinsic value		7 %	45 %	N.A.	171 %	161 %

Table 30: Intrinsic value of products and waste streams (BIRR/t).

As can be seen each product has a different breakdown and in particular:

- Different products are having different, resulting intrinsic values in absolute terms (BIRR/t)
- All the products have certain fractions that need to be properly disposed. There are no products without fractions with negative value.
- In some cases the intrinsic positive value is higher than the negative one, in other cases it's the opposite.

The intrinsic economic value is the potential economic gain (or cost) resulting after the treatment: this means that treatment costs should be considered as well to fully exploit the economic value.

But it's anyway interesting to compare, at this stage, the total intrinsic value with access to waste prices (Table 22) and refurbishment chain prices (Table 24):

- It's quite clear how the intrinsic economic value for products entering the recycling chain cannot compensate the access to waste when competing with refurbishment and reuse option;
- At same time, for many products, even the current access to waste prices are by far higher than the intrinsic economic potential (f.i. LHHA and C&F waste streams).
- For products like CRT (Monitors or TV) the intrinsic value is negative so further increasing the overall impact on total costs.

6.4.3 NET TREATMENT COSTS & PRICING STRATEGY

Evaluation of net treatment costs taking into account (i) technical treatment costs and (ii) intrinsic economic value of each product/waste stream is the most important step in the analysis of recycling plant operations and profitability:

- For some products (f.i. dismantled & mixed e-waste, desktop PC, washing machines and refrigerators) the net treatment cost is positive, while
- For other products (CRT-containing appliances) the net treatment costs is negative.

Where the net treatment cost is negative, the gap should be covered by external sources: this means that when anybody is delivering the product to the recycling plant, a fee should be paid to ensure the proper treatment (and the margin of the facility), as shown in Table 31.

In many cases considering the economic intrinsic value, the technical treatment costs and the profits of the recycling facility, certain surplus is remaining. Such surplus can be used primarily to:

- Finance access to waste for that specific product/waste stream partially (washing machines, mixed e-waste or refrigerators case) or totally (Desktop PC case).
- Cross-finance access to waste or technical treatment costs of other waste streams. This is particularly the case of the Desktop PC in Table 31.

Intrinsic value for products and cross-financing options (BIRR/t)	Dismantled & mixed e-waste	Desktop PC	CRT-Monitor	Washing Machine	Refrigerator
Total Treatment cost	-6,809	-4,540	-2,853	-684	-1,705
Net Intrinsic Value of waste	7,205	19,146	-4,013	3,860	3,950
Net Margin (Intrinsic Value - Treatment costs)	396	14,606	-6,866	3,176	2,245
Profit Margin (set)	20 %	20 %	15 %	20 %	20 %
Gap from external sources	0	0	7,895	0	0
Profit for AKAKI	79	2,921	1,030	635	449
Surplus (Intrinsic value minus Costs minus Profit)	317	11,684	0	2,541	1,796
Maximum financing of access to waste from AKAKI	63 %	100 %	0 %	38 %	28 %
Financing of access to waste from AKAKI or other technical costs	-317	-8,660	0	-2,541	-1,796
Surplus available for cross-financing of other waste streams	0	3,024	0	0	0

Table 31: Intrinsic value for products and cross-financing options (BIRR/t).

The table above clearly demonstrates some of the key principles of successful e-waste treatment business, seen as a standing alone phase in the entire recycling chain:

- Profits for recycling plants are resulting from the positive gap between intrinsic value and technical treatment costs or, in case of products with negative balance, from the margin set on the fees requested to the persons delivering the waste to the facility. This is providing the first, big, incentive to process as much waste as possible as, in both scenarios, the profitability is ensured.

- The existence of a financial surplus in certain waste streams, or for selected products, allows creating financial means to acquire more waste, to pursue the increase of waste processed. This could result in:
 - Financing access to waste (so purchase of waste to be treated),
 - Coverage of transportation costs (or costs for containers), or
 - Cross-financing of other waste streams (either in terms of access to waste, or compensation of part of their technical treatment costs).

Despite some products/waste streams could have a positive net treatment cost, it is very difficult that the economic surplus of the treatment phase outweighs completely the other technical costs. Thus a proper financing mechanism should be identified.

The specific decision on how to allocate and use the financial surplus defines the strategy of the recycling plant.

In a competitive scenario, where different recycling plants are active, the reduction of the fees for products/waste streams having a negative net treatment costs is usually pursued.

Alternatively the increase of volumes, purchasing waste in case of positive net treatment costs is a common strategic choice of plant managers.

On the other hand, the reduction and optimizations of internal operations, even through economies of scale, in order to reduce the technical treatment costs, is also an important leverage that plant management could use.

All in all, those elements are anyway a fundamental driver for the overall cost-effectiveness of the e-waste recycling chain, particularly minimizing the need of external financial support, irrespective of the financing model chosen.